

## **Steam System Survey Guide**

**Greg Harrell, Ph.D., P.E.**

## DOCUMENT AVAILABILITY

Reports produced after January 1, 1996, are generally available free via the U.S. Department of Energy (DOE) Information Bridge.

**Web site** <http://www.osti.gov/bridge>

Reports produced before January 1, 1996, may be purchased by members of the public from the following source.

National Technical Information Service  
5285 Port Royal Road  
Springfield, VA 22161  
**Telephone** 703-605-6000 (1-800-553-6847)  
**TDD** 703-487-4639  
**Fax** 703-605-6900  
**E-mail** [info@ntis.fedworld.gov](mailto:info@ntis.fedworld.gov)  
**Web site** <http://www.ntis.gov/support/ordernowabout.htm>

Reports are available to DOE employees, DOE contractors, Energy Technology Data Exchange (ETDE) representatives, and International Nuclear Information System (INIS) representatives from the following source.

Office of Scientific and Technical Information  
P.O. Box 62  
Oak Ridge, TN 37831  
**Telephone** 865-576-8401  
**Fax** 865-576-5728  
**E-mail** [reports@adonis.osti.gov](mailto:reports@adonis.osti.gov)  
**Web site** <http://www.osti.gov/contact.html>

This report was prepared as an account of work sponsored by an agency of the United States Government. Neither the United States Government nor any agency thereof, nor any of their employees, makes any warranty, express or implied, or assumes any legal liability or responsibility for the accuracy, completeness, or usefulness of any information, apparatus, product, or process disclosed, or represents that its use would not infringe privately owned rights. Reference herein to any specific commercial product, process, or service by trade name, trademark, manufacturer, or otherwise, does not necessarily constitute or imply its endorsement, recommendation, or favoring by the United States Government or any agency thereof. The views and opinions of authors expressed herein do not necessarily state or reflect those of the United States Government or any agency thereof.

## **STEAM SYSTEM SURVEY GUIDE**

Greg Harrell, Ph.D., P.E.

The University of Tennessee  
Energy, Environment, and Resources Center

Date Published: May 2002

Developed for the  
U.S. Department of Energy BestPractices Steam Program

Prepared by  
OAK RIDGE NATIONAL LABORATORY  
Oak Ridge, Tennessee 37831  
managed by  
UT-BATTELLE, LLC  
for the  
U.S. DEPARTMENT OF ENERGY  
under contract DE-AC05-00OR22725

# CONTENTS

	<b>Page</b>
LIST OF FIGURES .....	v
LIST OF TABLES .....	vii
NOMENCLATURE .....	ix
ACKNOWLEDGMENTS .....	xi
ABSTRACT.....	1-1
1. INTRODUCTION.....	1-1
2. PROFILING THE STEAM SYSTEM .....	2-1
2.1 OVERVIEW AND GENERAL PRINCIPLES .....	2-1
2.2 UTILITY COSTS.....	2-1
2.3 BENCHMARKS .....	2-3
2.4 CALL TO ACTION—STEAM SYSTEM PROFILING .....	2-4
3. IDENTIFYING STEAM PROPERTIES FOR THE SYSTEM .....	3-1
3.1 OVERVIEW AND GENERAL PRINCIPLES .....	3-1
3.2 CALL TO ACTION—IDENTIFYING STEAM SYSTEM PROPERTIES.....	3-1
4. OPPORTUNITIES FOR BOILER EFFICIENCY IMPROVEMENT .....	4-1
4.1 OVERVIEW AND GENERAL PRINCIPLES .....	4-1
4.2 BOILER EFFICIENCY .....	4-1
4.2.1 Example Boiler.....	4-2
4.2.2 Economics of Boiler Efficiency Improvement.....	4-3
4.2.3 Stack Losses .....	4-4
4.2.4 Blowdown Loss.....	4-13
4.2.5 Shell Loss .....	4-16
4.2.6 Unburned Fuel Loss .....	4-16
4.2.7 Boiler Efficiency Summary.....	4-17
4.3 BOILER LOADING .....	4-17
4.4 BOILER FUEL FLOW ESTIMATE .....	4-18
4.5 CALL TO ACTION—BOILER EFFICIENCY.....	4-19
5. EFFECTIVENESS OF RESOURCE UTILIZATION .....	5-1
5.1 OVERVIEW AND GENERAL PRINCIPLES .....	5-1
5.2 FUEL SELECTION .....	5-1
5.2.1 Fuel Switch Example .....	5-2
5.3 SYSTEM BALANCING.....	5-2
5.3.1 Vent Steam.....	5-3
5.3.2 Combined Heat and Power.....	5-4
5.4 PROCESS INTEGRATION.....	5-14
5.5 STEAM SYSTEM PRESSURE.....	5-14
5.6 CALL TO ACTION—EFFECTIVENESS OF RESOURCE UTILIZATION .....	5-15
6. STEAM DISTRIBUTION SYSTEM LOSSES .....	6-1
6.1 OVERVIEW AND GENERAL PRINCIPLES .....	6-1
6.2 STEAM LEAKS .....	6-1
6.2.1 Pipe Failures.....	6-1
6.2.2 Steam Traps.....	6-2
6.3 INSULATION.....	6-7
6.4 CONDENSATE RECOVERY.....	6-8
6.5 FLASH STEAM RECOVERY .....	6-9
6.6 CALL TO ACTION—DISTRIBUTION SYSTEM LOSSES.....	6-10

REFERENCES .....	R-1
Appendix A. STEAM PROPERTIES.....	A-1
Appendix B. STACK LOSS TABLES .....	B-1

## LIST OF FIGURES

Figure		Page
1	Example boiler.....	4-2
2	Design minimum metal temperatures.....	4-10
3	Flue gas path.....	4-12
4	ABMA typical shell loss.....	4-16
5	General steam system schematic.....	5-5
6	Steam turbine vs pressure-reducing valve example.....	5-8
7	Extraction condensing turbine arrangement.....	5-11
8	Flash steam recovery vessel.....	6-10



## LIST OF TABLES

Table		Page
1	Typical fuel properties .....	2-2
2	Steam properties .....	3-1
3	Flue gas oxygen content control parameters .....	4-5
4	Stack loss of No. 2 fuel oil .....	4-6
5	Boiler water chemical limits .....	4-14
6	Steam leak rates .....	6-2
7	Pipe surface heat transfer .....	6-8
A.1	Saturated vapor properties—pressure .....	A-3
A.2	Saturated vapor properties—temperature .....	A-4
A.3	Saturated liquid properties—pressure .....	A-5
A.4	Saturated liquid properties—temperature .....	A-6
A.5	Superheated steam properties .....	A-7
A.6	Subcooled liquid properties .....	A-9
B.1	Natural gas stack loss .....	B-3
B.2	No. 2 Fuel oil stack loss .....	B-3
B.3	No. 6 Fuel oil stack loss .....	B-4
B.4	Typical bituminous coal stack loss .....	B-4





## NOMENCLATURE

The following is a list of symbols used throughout this text.

$A$	flow area
$\dot{E}$	energy flow rate
HHV	fuel higher heating value
$h$	enthalpy
$\dot{K}$	operating cost
$\dot{m}$	mass flow rate
$P$	pressure
$\dot{Q}$	heat transfer rate
$T$	operating period
$\dot{V}$	volume flow rate
$\dot{W}$	power
$X$	thermodynamic quality (mass basis)
$\eta$	efficiency
$\kappa$	energy unit cost
$\rho$	density
$\sigma$	savings
$\Lambda$	loss rate
$\lambda$	loss
$\phi$	factor or ratio



## ACKNOWLEDGMENTS

The *Steam System Survey Guide* has been developed at the request of the U.S. Department of Energy's Office of Industrial Technologies. The author wishes to thank Tony Wright of the U.S. Department of Energy BestPractices Steam Program for his support and many reviews of this document. Appreciation is also extended to Carroll Hooper of Steam Solutions and William Mashburn of Virginia Polytechnic Institute and State University. Many additional people supported the efforts required to complete this document for which the author is greatly appreciative.



# STEAM SYSTEM SURVEY GUIDE

Greg Harrell, Ph.D., P.E.

## ABSTRACT

This *Steam System Survey Guide* provides technical information for steam system operational personnel and plant energy managers on some of the major opportunities available to improve the energy efficiency and productivity of industrial steam systems. The guide covers five main areas of investigation: (1) profiling a steam system, (2) identifying steam properties for the steam system, (3) improving boiler operations, (4) improving resource utilization in the steam system, and (5) investigating energy losses in the steam distribution system. The guide discusses major areas where steam systems can be improved and outlines calculations that can be performed to quantify steam system improvement opportunities.

---

## 1. INTRODUCTION

This *Steam System Survey Guide* is intended for steam system operational personnel and plant energy managers. Often operations personnel and energy managers are unaware of the opportunities available for energy and productivity savings in their steam systems, or they are unsure of the calculation procedures required to determine the savings opportunities. The purpose of this guide is to assist operations personnel and energy managers in identifying significant opportunities to improve their steam systems.

The *Steam System Survey Guide* does not attempt to guide steam system users in the implementation phase of improvement projects. In some cases, improvements may be simple to make, but others will require the assistance of qualified steam system experts. However, if the guidance of this document is followed, many possible opportunities for improving the steam system should be identified.

These guidelines are organized to assist steam users to take the following steps in identifying opportunities to improve their steam systems:

- First, the analysis basis must be determined; guidelines are provided for profiling individual steam systems. Methods are presented to estimate the fuel costs and operating characteristics of the facility and to identify improvements in energy efficiency that translate to operational cost savings.
- Second, the steam properties of the facility are identified to allow calculations to be performed in latter sections of the analysis.
- Third, the boiler operation is investigated. This analysis centers on evaluating the fuel-to-steam conversion efficiency of the boiler.
- The fourth analysis area is concerned with resource utilization throughout the facility. The main concerns in this area are to use the most appropriate fuel, to maintain the proper steam balance throughout the system, and to integrate process energy.

- The fifth category investigates the loss of energy throughout the distribution system. The main categories of loss are leaks, insufficient insulation, and unrecovered condensate.

Each section of the guide is organized as follows:

1. The focus area is described.
2. The opportunities for improvement are discussed.
3. Example calculations are provided to illustrate how to identify specific improvement opportunities.
4. A “Call to Action” is presented in the form of action items for areas that should be investigated to improve steam system operations.

## 2. PROFILING THE STEAM SYSTEM

### 2.1 OVERVIEW AND GENERAL PRINCIPLES

In general, operational changes are based on economic factors. Thus, the economics of the steam system should be determined. The main factors in this evaluation are associated with the fuel supplied to the boilers. The total cost of fuel supplied to the boilers will provide an order of magnitude of the economic potential associated with a proposed operational change. The unit cost of fuel is also important in the evaluation of system performance and operational changes. From the standpoint of managing the steam system, more measurements will allow more informed management. The energy management principle “You cannot manage what you do not measure” holds true.

### 2.2 UTILITY COSTS

The total cost of fuel supplied to the facility should be determined. Typically, this value is known from fuel invoices. This is a very important value from an operations and analysis standpoint. As boiler and steam system efficiency improves, the amount of fuel purchased decreases for a given steam production. This becomes the justification for any economic investment. Caution should be exercised to include only fuel supplied to the boilers. Many facilities have only one fuel metering device, and fuel may be used in process equipment or in heating and air conditioning equipment. If the amount of fuel supplied to the boilers is not metered, the fuel consumption can be estimated. The methods used in the estimation process will be discussed in Sect. 4.4, “Boiler Fuel Flow Estimate.”

The time that the boilers operate also needs to be determined to allow savings and cost evaluations to be based on the appropriate operating hours. Many facilities operate 24 h/d and 365 d/year. The operating hours,  $T$ , for this facility would be calculated as follows.

$$T = 24 \text{ h/d} (365 \text{ d/year}) = 8760 \text{ h/year} \quad . \quad (1)$$

A determination of fuel cost is essential for the efficient management of a steam system. Gaseous fuels are typically sold in units of 1000 standard cubic feet (i.e.,  $10^3 \text{ std ft}^3$ ,  $10^3 \text{ ft}^3$ , 1000 scf, and Mcf). Gaseous fuel pricing is also provided based on 100 standard cubic feet (Ccf). Fuel oils are typically sold in terms of gallons, while coal is sold primarily based on tons. A steam system survey investigates the use of energy throughout the steam system. Therefore, it is beneficial to determine the fuel cost on an energy basis. To accomplish this, some properties of the fuel must be known. The main property required is the fuel energy content that is termed the “fuel heating value.” In the United States, the higher heating value (HHV) is commonly used; in Europe and many other parts of the world, the lower heating value is used. The difference in the values is in the fuel analysis and, in particular, the state of the water involved in the combustion process. This guide will use the fuel HHV for all calculations. Fuel heating value and the fuel sales price are used to determine the fuel unit cost. Three examples of this calculation are provided below.

The first example is for natural gas with a purchase price of  $\$7.00/10^3 \text{ ft}^3$ . The example natural gas has an HHV of  $987,124 \text{ Btu}/10^3 \text{ ft}^3$  ( $23,000 \text{ Btu}/\text{lb}_m$ ). This results in a fuel cost,  $\kappa_{\text{natural gas}}$ , of  $\$7.09/10^6 \text{ Btu}$ .

$$\kappa_{\text{natural gas}} = \$7.00/10^3 \text{ ft}^3 \left( \frac{10^3 \text{ ft}^3}{987,124 \text{ Btu}} \right) \frac{1,000,000 \text{ Btu}}{10^6 \text{ Btu}} = \$7.09/10^6 \text{ Btu} \quad . \quad (2)$$



The next example determines the fuel cost,  $\kappa_{\text{No. 2}}$ , for No. 2 fuel oil with a purchase price of \$1.00/gal. The example No. 2 fuel oil has an HHV of 139,874 Btu/gal.

$$\kappa_{\text{No. 2}} = \$1.00/\text{gal} \left( \frac{1 \text{ gal}}{139,874 \text{ Btu}} \right) \frac{1,000,000 \text{ Btu}}{10^6 \text{ Btu}} = \$7.15/10^6 \text{ Btu} . \quad (3)$$

The final example is for coal that is purchased with a price of \$50.00/ton and an HHV of 13,500 Btu/lb<sub>m</sub>.

$$\kappa_{\text{coal}} = \$50.00/\text{ton} \left( \frac{1 \text{ ton}}{2,000 \text{ lb}_m} \right) \frac{1 \text{ lb}_m}{13,500 \text{ Btu}} \left( \frac{1,000,000 \text{ Btu}}{10^6 \text{ Btu}} \right) = \$1.85/10^6 \text{ Btu} . \quad (4)$$

The energy-based cost of coal,  $\kappa_{\text{coal}}$ , is typically much lower than the common liquid and gaseous fuels. These examples and several other common fuels are summarized in the Table 1.

**Table 1. Typical fuel properties**

Fuel	Typical sales unit	Example price (\$/sales unit)	Energy content (Btu/sales unit)	Energy content (Btu/lb <sub>m</sub> )	Unit price (\$/10 <sup>6</sup> Btu)	Fuel “density” (lb <sub>m</sub> /sales unit)
Natural gas	10 <sup>3</sup> standard ft <sup>3</sup>	7.00	987,124	23,000	7.09	42.92
No. 1 fuel oil	Gallon	1.18	134,510	19,810	8.77	6.79
No. 2 fuel oil	Gallon	1.00	139,874	19,400	7.15	7.21
No. 4 fuel oil	Gallon	0.76	146,731	18,860	5.18	7.78
No. 5 fuel oil	Gallon	0.60	146,891	18,760	4.08	7.83
No. 6 fuel oil	Gallon	0.51	145,485	18,300	3.51	7.95
Coal	Ton	50.00	27,000,000	13,500	1.85	2,000.00

The information contained in Table 1 is not representative of fuel prices and properties universally. The table demonstrates typical data for the purpose of providing examples. Each fuel has a wide range of properties and costs. These properties are provided as examples, and each facility should use data for that particular site.

Most fuels maintain consistent properties and are supplied based on certain specifications. In general, coal can have the widest range in properties because most other fuels are produced with certain tolerances. Coal storage and handling typically provides the opportunity for the fuel to contact water. Generally, coal is specified on a “dry” basis. However, the coal is not supplied to the burner on a dry basis. Therefore, to determine the actual performance of the boiler, periodic “as-fired” coal samples should be analyzed to determine the qualities of the coal supplied to the boiler. Periodic “as-received” coal samples should also be analyzed to determine what is actually being purchased. In these analyses, care must be given to the surface or extrinsic water. The surface water is part of the commodity purchased and supplied to the boiler. It does affect the boiler performance; therefore, surface water should not be lost in the analysis. Coal analysis typically grinds the coal prior to analysis. This grinding evaporates the surface water, which can provide test results with erroneously low moisture values.

Care should also be exercised in understanding the fuel pricing structure. When determining the economic benefit of an efficiency improvement, only the incremental cost of fuel is affected. For example, the first 500 10<sup>3</sup> ft<sup>3</sup> of natural gas purchased each month may carry a price of \$7.50/10<sup>3</sup> ft<sup>3</sup>; the remaining natural gas purchased may carry a lower price of \$6.75/10<sup>3</sup> ft<sup>3</sup>. If the

facility always consumes much more than  $500 \times 10^3 \text{ ft}^3$  of natural gas each month, an increase in boiler efficiency will impact the system according to a fuel cost of  $\$6.75/10^3 \text{ ft}^3$ .

Electricity is a significant utility supply to most industrial facilities. A good point of comparison is between the unit cost of fuel and electricity. Electrical rate structures are generally complicated, but the main components are usually electrical demand and energy. Electrical energy charges are determined from the total amount of energy consumed at the site—the total kilowatt-hour (kWh) value of energy consumed. Electrical demand charge is based on the maximum rate of electrical energy consumption for the site during the billing period. Electrical energy charges are provided on a dollar per kilowatt-hour ( $\$/\text{kWh}$ ) basis, while demand charges are based on a monthly dollar-per-kilowatt basis. These two factors combine to determine the total electrical cost at the facility. To compare electrical costs to fuel costs, they must be examined on an equal energy basis. Electrical costs can be converted to a British-thermal-unit (Btu) basis fairly simply. The following conversion can be used to determine the electrical energy unit cost. An electrical cost of  $\$0.040/\text{kWh}$  for energy ( $\kappa_{\text{electrical energy}}$ ) and  $\$14.60/\text{kW}$  each month for demand ( $\kappa_{\text{electrical demand}}$ ) will be used in the example.

$$\kappa_{\text{electrical energy}} = \$0.04/\text{kWh} \left( \frac{1 \text{ kWh}}{3,413 \text{ Btu}} \right) \frac{1,000,000 \text{ Btu}}{10^6 \text{ Btu}} = \$11.72/10^6 \text{ Btu} . \quad (5)$$

$$\kappa_{\text{electrical demand}} = \$14.60/\text{kW month} \left( \frac{1 \text{ kWh}}{3,413 \text{ Btu}} \right) \frac{1,000,000 \text{ Btu}}{10^6 \text{ Btu}} \left( \frac{1 \text{ month}}{730 \text{ h}} \right) = \$5.86/10^6 \text{ Btu} . \quad (6)$$

These two charges would be added for a combined demand and energy charge of  $\$17.58/10^6 \text{ Btu}$  ( $\$0.060/\text{kWh}$ ). This can be compared to the fuel cost to determine the most appropriate energy source for various applications. This would not be the final analysis because many factors must be integrated into the analysis (such as boiler efficiency and steam system losses), but this would provide an indication of the relative cost of energy sources.

### 2.3 BENCHMARKS

Benchmarking is the practice of determining key operating parameters of a system to provide points of comparison. Benchmarking is a valuable tool to track system performance, to identify problems, and to determine the effectiveness of system alterations. Some practical benchmarks are boiler efficiency, steam unit cost, and finished product energy requirement. The variation in steam flow with plant production and with the seasons can also provide valuable input for system improvement analysis.

One universal or common benchmark is annual fuel expenditure. Annual fuel expense is not a classic benchmark because benchmarks are references to a unit of production or consumption. However, annual fuel expense is a key indicator of steam system activities, and it is a common tracking indicator.

Benchmarks can be used to compare a facility with a theoretical system to determine the maximum attainable performance (classic efficiency). Benchmarks are also used to compare the current operation to past operation. This can identify potential failures within the system as well as highlight efficiency and production improvements. Another common use of benchmarks is to compare similar facilities.

A direct example of a benchmark is steam production unit cost. Some facilities are equipped with steam flowmeters, which can be used in conjunction with the total fuel cost to determine the steam cost. As an example, a steam generation facility produces 2,400,000 lb of steam in a 24-h period. During the same period 27,780 gal of No. 2 fuel oil is consumed. The following

calculation demonstrates the method used to calculate the relative steam cost for the facility, the benchmark. The fuel cost is \$1.00/gal, and conversion factors must be introduced into the calculations to maintain appropriate units.

$$\kappa_{\text{steam}} = \frac{\text{fuel consumed}}{\text{steam produced}} (\text{fuel price}) . \quad (7)$$

$$\kappa_{\text{steam}} = \frac{27,780 \text{ gal/d}}{2,400,000 \text{ lb/d}} (\$1.00/\text{gal}) \frac{1,000 \text{ lb}_m}{10^3 \text{ lb}_m} = \$11.58/10^3 \text{ lb}_m .$$

The unit cost of steam ( $\kappa_{\text{steam}}$ ) provided by Eq. (7) is not the steam “sales” price or the cost of steam distributed to the facility because some portion of the steam produced from the boiler must be used internally in the production of steam. This steam is used in deaeration, feedwater heating, possibly sootblowing, and other internal activities. The steam cost benchmark is a concrete marker that represents the boiler’s performance.

The information in the example is a part of a reference example used throughout this document. Additional information concerning this “example system” is provided throughout the text with the majority of the information given in Sect. 4.2.1, “Example Boiler.” As indicated previously, a common reference is total fuel expense or the fuel portion of the boiler operating cost. Boiler operating cost ( $\dot{K}_{\text{boiler}}$ ) is calculated below.

$$\dot{K}_{\text{boiler}} = \text{fuel consumed (fuel price)} = \dot{V}_{\text{fuel}} \kappa_{\text{fuel}} . \quad (8)$$

$$\dot{K}_{\text{boiler}} = 27,780 \text{ gal/d} (\$1.00/\text{gal}) 365 \text{ d/year} = \$10,140,000/\text{year} .$$

## 2.4 CALL TO ACTION—STEAM SYSTEM PROFILING

1. Determine the total cost of fuel supplied to the boilers (\$/year, \$/month, and \$/season).
2. Calculate the unit cost of fuel based on energy (\$/10<sup>6</sup> Btu).
3. Compare the unit cost of fuel to other available fuel supplies.
4. Determine the unit cost of electricity supplied to the facility (\$/10<sup>6</sup> Btu).
5. Compare the unit cost of fuel to the cost of electricity supplied to the facility.
6. Determine the typical steam production for the facility (lb<sub>m</sub>/h and lb<sub>m</sub>/d).
7. Determine the production cost of steam for the facility (\$/10<sup>3</sup> lb<sub>m</sub>).
8. Determine the amount of steam required to produce a product (lb<sub>m</sub> steam/lb<sub>m</sub> product).

### 3. IDENTIFYING STEAM PROPERTIES FOR THE SYSTEM

#### 3.1 OVERVIEW AND GENERAL PRINCIPLES

A steam system analysis investigates the energy transfer of the fuel to the steam and the steam to the process. To complete the analysis, steam properties must be known. Steam properties are provided in tabular, graphical, and computerized form.<sup>1-3</sup> Typically the values used to determine properties are the steam temperature and pressure if the steam is superheated. When steam is dry and saturated, pressure or temperature can be utilized to determine the steam properties. If dealing with saturated condensate, pressure or temperature are also the common properties used to provide fluid information. Finally, temperature and pressure are used to determine the properties of water below the saturation temperature (subcooled). Many other methods can be used to determine steam and water properties, but temperature and pressure are the most common measurements. Table 2 provides some typical steam properties for a boiler operating at 600 psig and producing superheated steam (750°F). Atmospheric pressure is 14.7 psia for the example.

**Table 2. Steam properties**

Location	Temperature (°F)	Pressure (psia)	Specific volume (ft <sup>3</sup> /lb <sub>m</sub> )	Internal energy (Btu/lb <sub>m</sub> )	Enthalpy (Btu/lb <sub>m</sub> )	Entropy (Btu/lb <sub>m</sub> °R)	Quality (%)
<b>Boiler outlet</b>	750	614.7	1.10357	1,253.42	1,378.95	1.60856	
<b>Medium pressure</b>	621	214.7	2.90619	1,216.42	1,331.88	1.67829	
<b>Intermediate pressure</b>	407	54.7	9.26341	1,143.99	1,237.76	1.72833	
<b>Low pressure</b>	429	23.8	22.08426	1,155.16	1,252.43	1.83571	
<b>Boiler blowdown</b>	489	614.7	0.02018	472.35	474.64	0.67502	0.0
<b>Makeup water</b>	60	14.7	0.01600	28.02	28.07	0.05552	
<b>Condensate return</b>	180	14.7	0.01650	147.87	147.91	0.26289	
<b>Deaerator outlet</b>	237	23.8	0.01690	205.61	205.68	0.34938	0.0
<b>Feedpump exit</b>	241	915.2	0.01690	206.80	209.66	0.35507	

Makeup water is the water introduced into the system because steam or condensate is lost from the system; this water is relatively cold. Condensate return is water returned to the boilers from steam users. Usually this water is relatively warm, unless returned from turbine condensers.

Most calculations completed on steam systems are investigating the energy associated with an activity. Typically, the thermodynamic property used to determine energy flow is enthalpy. Enthalpy is expressed in terms of specific energy content for a given mass of material; the common English units are British thermal units per pound mass (Btu/lb<sub>m</sub>). Enthalpy is expressed in equations as the variable  $h$ ; this is the convention used throughout this text. Additional data are provided in Table 2, which is used in some calculations.

#### 3.2 CALL TO ACTION—IDENTIFYING STEAM SYSTEM PROPERTIES

1. Determine the properties of the steam generated in the boilers (temperature, pressure, saturated, superheated, enthalpy, and the remaining thermodynamic properties).
2. Determine the properties of boiler feedwater (temperature, pressure, enthalpy).
3. Determine the properties of boiler blowdown (pressure, enthalpy).
4. Determine the properties of condensate return (temperature).
5. Determine the properties of makeup water (temperature).

## 4. OPPORTUNITIES FOR BOILER EFFICIENCY IMPROVEMENT

### 4.1 OVERVIEW AND GENERAL PRINCIPLES

Steam production is basically an energy conversion process in which fuel energy is converted into energy resident in steam. Boilers are the most energy-intensive components of a steam system. This implies energy management should have a focal point on the boilers. Several factors are key ingredients in boiler performance.

Typically the most significant loss associated with boiler operation is the energy exiting the boiler with the flue gas. This loss is directly impacted by the temperature of the flue gas and the amount of excess air supplied to the combustion process. Other combustion factors also impact this portion of the energy conversion process.

Additional factors that impact boiler performance must also be considered. Boiler blowdown is essential for the continued operation of any steam boiler. Boiler blowdown is also a loss to the boiler operation. To a large extent, this loss can be managed and reduced. Heat transfer losses from the boiler shell are also an area of potential loss management.

### 4.2 BOILER EFFICIENCY

Generally, efficiency is an expression of the amount of desired output from a component compared to the input required. Boiler efficiency,  $\eta_{\text{boiler}}$ , is accurately defined by the following expression.

$$\eta_{\text{boiler}} = \text{boiler efficiency} = \frac{\text{energy added to the steam in the boiler}}{\text{energy supplied with the fuel}} \quad (9)$$

To utilize this expression, it must be provided in terms of steam system properties. The following equation is the working equation for boiler efficiency.

$$\eta_{\text{boiler}} = \frac{\dot{m}_{\text{steam}}(h_{\text{steam}} - h_{\text{feedwater}})}{\dot{m}_{\text{fuel}}\text{HHV}} \quad (10)$$

where

$\dot{m}_{\text{steam}}$  = mass flow rate of steam,

$h_{\text{steam}}, h_{\text{feedwater}}$  = enthalpies of steam and feedwater,

$\dot{m}_{\text{fuel}}$  = mass flow rate of fuel,

HHV = fuel higher heating value.

Equation (10) is termed “boiler efficiency” and is the classic definition of efficiency according to the first law of thermodynamics. Care must be utilized because the term “boiler efficiency” is used in several instances to describe energy conversion processes associated with the boiler.

To use Eq. (10), several measurements must be made. These measurements should be made during a period of steady operation in which the boiler has been producing a constant steam flow for approximately 1 h. During the data gathering period, the water level in the boiler’s steam drum should be constant. Additional measurements required are steam temperature and pressure exiting the boiler. Feedwater pressure and temperature are also required parameters. These steam and feedwater properties provide the information required to determine the enthalpy content of the water entering and steam exiting the boiler. This “enthalpy addition” is a measure of the

useful output of the boiler. The desired output from a boiler is an addition of energy to the steam flow. Fuel flow rate and energy content of the fuel are also required measurements. Generally, fuel energy content is supplied from a laboratory analysis.

#### 4.2.1 Example Boiler

As an example, a boiler producing 100,000 lb<sub>m</sub>/h of superheated steam (750°F) at 600 psig will be considered. Figure 1 is a general representation of the primary operating conditions associated with the boiler. This example boiler is not operating with optimum efficiency as will be pointed out in the discussions to follow.

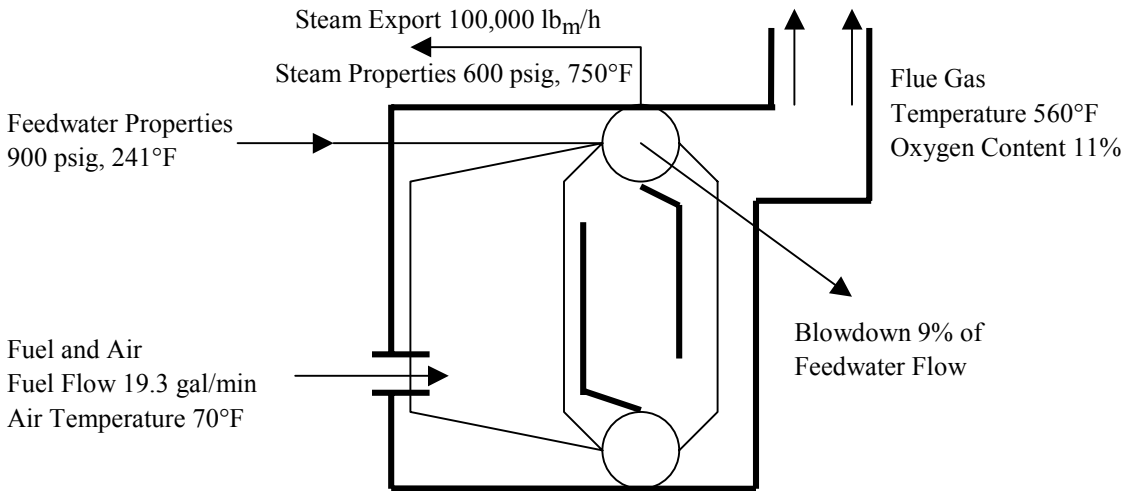

Fig. 1. Example boiler.

The steam and water enthalpies ( $h_{\text{steam}}$  and  $h_{\text{feedwater}}$ ) are provided in Table 2. The feedwater supplied to the boiler drum exits the boiler feed pump with a pressure of 900 psig and a temperature of 241°F. The fuel supplied to the boiler is No. 2 fuel oil with an HHV of 19,400 Btu/lb<sub>m</sub>. The HHV is provided in Table 1. Fuel supplied to the boiler is measured at a rate of 19.3 gal/min. Fuel mass flow rate is determined by using the fuel density found in the Table 1. Density for No. 2 fuel oil is 7.21 lb<sub>m</sub>/gal. The fuel mass flow rate,  $\dot{m}_{\text{fuel}}$ , is calculated below.

$$\dot{m}_{\text{fuel}} = \text{fuel volume flow (fuel density)} = \dot{V}_{\text{fuel}} \rho_{\text{fuel}} \quad (11)$$

$$\dot{m}_{\text{fuel}} = 19.3 \text{ gal/min (60 min/h)} 7.21 \text{ lb}_m/\text{gal} = 8349 \text{ lb}_m/\text{h} .$$

From this, all of the information is known to allow the efficiency to be calculated from Eq. (10) as follows.

$$\eta_{\text{boiler}} = \frac{100,000 \text{ lb}_m/\text{h}(1,378.95 \text{ Btu}/\text{lb} - 209.66 \text{ Btu}/\text{lb}_m)100}{8,349 \text{ lb}_m/\text{h}(19,400 \text{ Btu}/\text{lb}_m)} = 72.2\% . \quad (12)$$

Efficiency should be monitored frequently and used as a benchmark. This classic efficiency formulation is not the only accurate method available to determine boiler efficiency. In fact, many facilities do not have the measuring components in place to allow this type of efficiency determination. In those cases, efficiency will be determined by identifying the magnitude of the

individual losses associated with steam generation. This efficiency evaluation is classified as an “indirect” method. The general expression used in the indirect efficiency,  $\eta_{\text{indirect}}$ , determination follows.

$$\eta_{\text{indirect}} = 100\% - \sum_{\text{losses}} \lambda_i \quad . \quad (13)$$

Boiler losses,  $\lambda_i$ , are described in the following sections but are generally classified as stack loss, blowdown loss, shell loss, and miscellaneous losses. These losses are expressed as a percentage of total fuel input energy. Indirect efficiency, Eq. (13), and boiler efficiency, Eq. (10), are theoretically identical. In practice measurement errors, minor loss omissions and unsteady conditions result in differences in these values.

The boiler identified in the preceding example will be used as an example throughout this guide to demonstrate the analysis procedures. A determination of the magnitude of the energy added with the fuel is beneficial in many of the analyses to come. The energy added with the fuel is the denominator of Eq. (10). An example calculation follows.

$$\text{Energy added with the fuel} = \dot{E}_{\text{fuel}} = \dot{m}_{\text{fuel}} \text{ HHV} \quad . \quad (14)$$

$$\dot{E}_{\text{fuel}} = 8,349 \text{ lb}_m/\text{h} (19,400 \text{ Btu}/\text{lb}_m) = 161,971,000 \text{ Btu}/\text{h} \quad .$$

Another useful entity is the amount of energy added to the steam in the boiler. This can be calculated utilizing Eq. (15).

$$\begin{aligned} \dot{E}_{\text{steam}} &= \dot{m}_{\text{steam}} (h_{\text{steam}} - h_{\text{fw}}) = 100,000 \text{ lb}_m/\text{h} (1,378.95 \text{ Btu}/\text{lb}_m - 209.66 \text{ Btu}/\text{lb}_m) \\ &= 116,929,000 \text{ Btu}/\text{h} \quad . \quad (15) \end{aligned}$$

A quick comparison demonstrates the ratio of Eq. (15) to Eq. (14) is the definition of boiler efficiency [Eq. (10)].

#### 4.2.2 Economics of Boiler Efficiency Improvement

As stated previously, changes in operating conditions are generally precipitated because of economic factors. Therefore, to recommend boiler efficiency improvement projects an evaluation of the economics associated with the improvement must be made. The equations provided below demonstrate the methodology utilized to determine the savings potential associated with increasing boiler efficiency.

In many boiler efficiency improvement analyses, the amount of steam produced by the boiler does not change after the improvement has been completed. The major factor changed by the efficiency improvement measure is the amount of fuel required to produce the given amount of steam. Therefore, the *energy input to the steam* remains constant for the analysis. Energy input to steam was defined by Eq. (15). Fuel energy input to the boiler is related to steam energy through boiler efficiency.

$$\text{Fuel input energy} = \dot{E}_{\text{fuel}} = \frac{\dot{m}_{\text{steam}} (h_{\text{steam}} - h_{\text{fw}})}{\eta_{\text{boiler}}} \quad . \quad (16)$$

When boiler efficiency is improved by reducing stack loss, steam energy input remains constant, but boiler efficiency changes. The change in operating cost (savings,  $\sigma$ ) is merely the difference in the initial operating cost and the final or adjusted operating cost.

$$\sigma = \dot{K}_{\text{initial}} - \dot{K}_{\text{final}} = \frac{\dot{E}_{\text{steam}}}{\eta_i} \kappa_{\text{fuel}} - \frac{\dot{E}_{\text{steam}}}{\eta_f} \kappa_{\text{fuel}} \quad . \quad (17)$$

This equation can be rearranged to provide a more appropriate form that will be used throughout this text.

$$\begin{aligned} \sigma &= \frac{\eta_i}{\eta_i} \frac{\dot{E}_{\text{steam}}}{\eta_i} \kappa_{\text{fuel}} - \frac{\eta_i}{\eta_i} \frac{\dot{E}_{\text{steam}}}{\eta_f} \kappa_{\text{fuel}} \quad . \\ \sigma &= \frac{\dot{E}_{\text{steam}}}{\eta_i} \kappa_{\text{fuel}} \left( \frac{\eta_i}{\eta_i} - \frac{\eta_i}{\eta_f} \right) = \dot{K}_{\text{initial}} \left( 1 - \frac{\eta_i}{\eta_f} \right) = \dot{K}_{\text{initial}} (1 - \phi) \quad . \end{aligned} \quad (18)$$

The ratio of efficiencies,  $\eta_i/\eta_f$ , is termed “fuel reduction factor” and is designated as  $\phi$ . The variable  $\dot{K}_{\text{initial}}$  is the initial operating cost (associated with fuel) of the boiler.

As an example, assume that stack loss can be reduced from 25% to 20% for the example boiler. As a result, boiler efficiency will be expected to improve from 75% to 80% (assuming other losses are negligible and do not change). The example boiler operates with an initial fuel cost of \$10,140,000/year. If the efficiency of this boiler can be improved five percentage points, the expected reduction in fuel consumption is calculated below.

$$\sigma = \$10,140,000/\text{year} \left( 1 - \frac{75\%}{80\%} \right) = \$10,140,000/\text{year} (1 - 0.938) = \$633,750/\text{year} \quad . \quad (19)$$

#### 4.2.3 Stack Losses

Boiler stack loss is typically the major loss component associated with the boiler operation. Many factors are incorporated in the stack loss category, but the major contributors are the flue gas temperature and excess air amount. Rarely do these losses combine to be less than 8% of the total fuel energy input to the boiler, and generally they result in more than a 15% loss.

Stack loss is usually determined through a combustion analysis. The analysis can be completed in many different ways with the most common being conducted with tabular data, graphical data, or electronic data. The analysis is based on combustion principles with the main input or measured data being flue gas exit temperature, ambient temperature, and flue gas oxygen content. The result of this analysis is the stack loss associated with the boiler operation. This is a representation of the amount of energy exiting the boiler with the flue gas in comparison to the total energy entering the boiler with the fuel. Commonly, stack loss is converted into an expression of efficiency termed “combustion efficiency,”  $\eta_{\text{combustion}}$ . Combustion efficiency is determined by the equation that follows.

$$\eta_{\text{combustion}} = 100\% - \lambda_{\text{stack}} \quad . \quad (20)$$

This equation is very similar to the indirect efficiency expression provided as Eq. (13). In fact, combustion efficiency represents the major components of indirect efficiency with shell



losses, blowdown losses, and miscellaneous losses omitted. Stack loss,  $\lambda_{\text{stack}}$ , is the only loss considered in combustion efficiency and is expressed as a percentage of total fuel input energy. In this guide, evaluation of stack loss will be completed through the use of tabular data. This may not be the most appropriate form for many analyses, but it is the vehicle used here. Stack loss tables can be found in Appendix B.

Because stack losses can be massive and are generally the largest loss in magnitude, they require close management. The investigation of stack losses will be segregated into the two main categories, temperature effect and excess air effect. These investigations follow.

#### 4.2.3.1 Flue gas oxygen content

Steam generation efficiency centers around the energy transfer process in the boilers. The main factors affecting the efficiency of this energy transfer process are the temperature of the exiting flue gas and the flue gas oxygen content. These issues are related in many areas. Flue gas oxygen content can represent a significant loss to the steam system if the content is not maintained within the proper limits.

In the combustion process, fuel must come in contact with oxygen to allow the release of the chemical energy resident in the fuel. If the fuel does not react, it leaves the combustion area and the boiler. This is a loss to the system because the fuel energy, which was purchased, was not released. This also presents a safety and environmental hazard because combustion can result in boiler areas not designed for combustion. Also, the partial combustion of the fuel will form carbon monoxide, which is a toxic low-grade fuel. An additional factor accompanying reduced oxygen content is the potential to produce smoke or opacity. This is a result of poor combustion and is the formation of particles from partial combustion of the fuel.

These conditions must be avoided; therefore, excess oxygen is supplied to the combustion zone to ensure that all of the fuel is combusted. However, this excess oxygen enters the boiler at ambient temperature, 70°F for example, and exits the boiler with the flue gas at an elevated temperature, 450°F for example. Therefore, the extra air brought into the boiler was heated from ambient temperature to flue gas temperature by the fuel. Further compounding the problem is the fact that the oxygen source is ambient air, which contains much more nitrogen than it does oxygen. The nitrogen does nothing for the combustion process except to extract energy and increase the loss. Management of this flue gas loss requires the excess oxygen to be maintained within a range. The appropriate range depends on the fuel type and the method of monitoring and control.

Table 3 provides some general information of the typical control limits for steam boilers. The table represents the amount of oxygen ( $O_2$ ) in the flue gas as it exits the combustion

**Table 3. Flue gas oxygen content control parameters**

Fuel	Automatic control flue gas $O_2$ content		Positioning control flue gas $O_2$ content		Automatic control excess air		Positioning control excess air	
	Minimum	Maximum	Minimum	Maximum	Minimum	Maximum	Minimum	Maximum
	(%)	(%)	(%)	(%)	(%)	(%)	(%)	(%)
<b>Natural gas</b>	1.5	3.0	3.0	7.0	8.5	18.0	18.0	55.0
<b>No. 2 fuel oil</b>	2.0	3.0	3.0	7.0	11.0	18.0	18.0	55.0
<b>No. 6 fuel oil</b>	2.5	3.5	3.5	8.0	14.0	21.0	21.0	65.0
<b>Pulverized coal</b>	2.5	4.0	4.0	7.0	14.0	25.0	25.0	50.0
<b>Stoker coal</b>	3.5	5.0	5.0	8.0	20.0	32.0	32.0	65.0

chamber. This is also expressed as excess air. Excess air is the amount of air introduced to the combustion zone in comparison to the theoretical, stoichiometric amount, required for complete combustion with no excess air. The excess air values in the table correspond to the flue gas oxygen content values.

The two main designations in Table 3 are automatic control and positioning control. Positioning control is generally accomplished as part of an overall boiler control system without flue gas oxygen measurement. Typically, a pressure controller observing steam pressure is the main system controller. As the steam pressure decreases, the controller will increase fuel flow to increase boiler steam output. Combustion air flow will be increased in a preset manner in response to the fuel flow setting. Combustion air is not adjusted based on flue gas oxygen content. Periodically the relationship between the combustion air setting and the fuel flow is verified and adjusted through flue gas oxygen content evaluation.

Nonautomatic control is also accomplished through monitoring of the flue gas oxygen content and manually adjusting the quantity of combustion air. This type of operation is usually found on boilers with constant load.

Automatic control refers to any type of boiler control that continually monitors flue gas oxygen content and adjusts the combustion air flow to maintain required limits. Any type of control will result in a range of flue gas oxygen content. Most boilers operate with less excess oxygen requirement at higher loads than at lower loads primarily because of the improved mixing and combustion parameters at higher loads.

The example boiler has a flue gas exit temperature of 560°F and a combustion air inlet temperature of 70°F. This produces a net flue gas temperature of 490°F (560°F – 70°F). The flue gas oxygen content was measured to be 11.0%. Table 4 identifies the loss associated with the energy exiting the boiler with the flue gas, 25.18%. This table and those for other fuels are found in Appendix B.

If this loss can be reduced, by recovering energy to the steam, the operating cost of the boiler will decrease. The example boiler initially has no automatic combustion controls or flue gas monitoring. Even without flue gas monitoring and control, this boiler should be capable of operating with a flue gas oxygen content ranging between 3.0% and 7.0%. If the oxygen content is reduced to an average of 5.0% and the flue gas exhaust temperature remains constant, the

**Table 4. Stack loss of No. 2 fuel oil (%)**

Flue gas O <sub>2</sub> content (%)	Flue gas temperature—combustion air temperature (°F)														
	230	250	270	290	310	330	350	370	390	410	430	450	470	490	510
<b>1.00</b>	10.33	10.74	11.16	11.58	12.00	12.43	12.85	13.28	13.70	14.13	14.56	14.99	15.42	15.85	16.28
<b>2.00</b>	10.55	10.99	11.43	11.87	12.31	12.75	13.20	13.64	14.09	14.54	14.99	15.44	15.89	16.34	16.79
<b>3.00</b>	10.79	11.25	11.72	12.18	12.65	13.11	13.58	14.05	14.52	14.99	15.46	15.94	16.41	16.89	17.36
<b>4.00</b>	11.07	11.56	12.04	12.53	13.02	13.52	14.01	14.50	15.00	15.50	15.99	16.49	17.00	17.50	18.00
<b>5.00</b>	11.38	11.89	12.41	12.93	13.45	13.97	14.49	15.01	15.54	16.07	16.59	17.12	17.65	18.18	18.72
<b>6.00</b>	11.73	12.28	12.83	13.38	13.93	14.48	15.04	15.59	16.15	16.71	17.27	17.83	18.40	18.96	19.53
<b>7.00</b>	12.13	12.72	13.30	13.89	14.48	15.07	15.66	16.26	16.85	17.45	18.05	18.65	19.25	19.85	20.45
<b>8.00</b>	12.60	13.22	13.85	14.48	15.11	15.75	16.38	17.02	17.66	18.30	18.94	19.58	20.23	20.88	21.52
<b>9.00</b>	13.14	13.81	14.49	15.17	15.85	16.54	17.22	17.91	18.60	19.29	19.98	20.68	21.38	22.07	22.77
<b>10.00</b>	13.77	14.51	15.25	15.99	16.73	17.47	18.22	18.96	19.71	20.46	21.22	21.97	22.73	23.49	24.25
<b>11.00</b>	14.54	15.35	16.15	16.96	17.78	18.59	19.41	20.23	21.05	21.87	22.70	23.52	24.34	25.18	26.02
<b>12.00</b>	15.48	16.37	17.26	18.16	19.06	19.96	20.87	21.77	22.68	23.59	24.51	25.42	26.34	27.26	28.18

combustion loss will reduce to 18.18%. In other words, the boiler efficiency will improve 7.0 percentage points (25.18% to 18.18%). The initial boiler efficiency was determined to be 72.2%. After tuning the boiler, the efficiency would increase to 79.2%. This assumes that blowdown losses, shell losses, and other miscellaneous losses remain constant (approximately 2.6% of fuel energy input). An oxygen content of 5.0% was chosen because the boiler would be operating within the control range of flue gas oxygen content (3.0% to 7.0%). The approximate savings is calculated below [Eq. (8) is referenced for boiler operating cost].

$$\phi = \frac{\eta_{\text{old}}}{\eta_{\text{new}}} = \frac{72.2\%}{79.2\%} = 0.912 \quad . \quad (21)$$

$$\sigma = \dot{K}_{\text{boiler}} (1 - \phi) = \$10,140,000/\text{year} (1 - 0.912) = \$896,200/\text{year} \quad . \quad (22)$$

The savings is approximate and should be reported as approximately \$900,000/year. This savings should be attainable with relatively minor investment. The revised boiler operating cost (fuel only) would be \$9,245,000/year.

The example boiler could be equipped with an automatic oxygen trim system to further reduce the stack loss. The oxygen trim system could control the flue gas oxygen content to 2.5%. In this case the combustion loss would decrease to 16.6% if the flue gas temperature remains constant. In other words, the boiler efficiency would increase to 80.8%. The potential savings is calculated below.

$$\phi = \frac{\eta_{\text{old}}}{\eta_{\text{new}}} = \frac{79.2\%}{80.8\%} = 0.980 \quad . \quad (23)$$

$$\sigma = \dot{K}_{\text{boiler}} (1 - \phi) = \$9,245,000/\text{year} (1 - 0.980) = \$183,000/\text{year} \quad . \quad (24)$$

This is a significant savings that will require some amount of investment in the form of combustion control equipment. The economics of this project appear favorable, but further analysis would be required to determine the total project cost associated with the installation of the combustion control equipment.

Care should be given to the oxygen measurement location. This is true especially for boilers that operate with a negative pressure in the combustion zone and downstream of the combustion zone. Boilers operating with a negative pressure will have some air leaking into the flue gas stream. This air has not passed through the combustion zone and as a result did not contribute to the combustion process. This can provide a false oxygen reading that results in poor combustion performance if the input air flow is reduced based on this erroneous measurement. Therefore, the oxygen content should be measured as close to the combustion zone as possible. However, the combustion zone environment is extremely harsh, and a compromise must be reached. The idea is to install the oxygen sensor as close to the combustion zone as practical to achieve an acceptable sensor life and accurate measurement.

In the example analysis, flue gas temperature was assumed to remain constant when excess air was reduced. Typically, flue gas temperature will not remain constant as the amount of excess air is adjusted. In general, flue gas temperature will decrease as excess air is decreased. However, this is not universal and should be investigated on a case-by-case basis.

#### 4.2.3.1.1 Flue gas combustibles

A secondary measurement, which is extremely helpful in determining combustion performance, is a measurement of the concentration of combustible material remaining in the flue gas

after the combustion zone. Poor or incomplete combustion can result even if the appropriate amount of oxygen is introduced to the combustion chamber. Three main factors affect combustion: (1) reaction time, (2) reaction temperature, and (3) reactants mixture.

For the combustion reaction to proceed to completion, fuel and oxygen must have enough time, they must be at the proper temperature, and they must be appropriately mixed. If any component is missing, the reaction will not proceed to completion. Babcock and Wilcox describes this as “the three T’s of combustion; Time, Temperature, and Turbulence.”<sup>4</sup> The main chemical component arising from incomplete combustion is carbon monoxide. Periodic carbon monoxide (or combustibles) measurement can provide insight into the performance of the combustion zone.

A generally accepted limit is to have no more than 200 parts per million (ppm) combustibles in the flue gas. However, this limit is general, and each boiler should be investigated to determine the base combustibles level. After the base level has been established, periodic monitoring will allow changes in combustibles concentration to be observed as a problem in the combustion process. As an example, a natural-gas-fired boiler may have 15 ppm combustibles in the flue gas under normal operating conditions. An indication of a combustion problem would be if the combustibles concentration increased to 50 ppm (well below the generally accepted limit).

#### **4.2.3.1.2 Flammability limits**

Not only must fuel and air be in the appropriate concentrations to obtain efficient combustion, but they must be within proper limits to establish a flame at all. For example, methane (natural gas essentially) must be mixed with at least 85% air (by volume) and no more than 95% air to burn.<sup>5</sup> This indicates that the air fuel mixture will not burn if there is more than 100% excess air (10% oxygen in the combustion products). However, many boilers are found operating with more excess air than this. The explanation is that the full amount of extra air is not passing through the flame zone. Air is either entering as “tramp air” through a shell leak, or it is entering through the combustion air system but is not affecting the flame zone. Even though this air is not passing through the flame zone, it is still affecting the boiler efficiency by absorbing energy from the fuel.

The point of this discussion arises from the method of attack to reduce stack loss. Typically excess air loss is reduced by more precise control of the combustion air entering the flame zone. However, if a significant portion of the air passing through the boiler does not pass through the flame zone, then reducing flue gas oxygen content may result in a substoichiometric condition (oxygen starved) in the flame zone. This can result in an explosion and other detriments of an economic nature. When correcting boilers with gross errors in flue gas oxygen content, care must be exercised to ensure that combustion is not compromised. In fact, care must be exercised for all boilers. This is accomplished by periodically measuring flue gas combustibles concentrations.

#### **4.2.3.2 Flue gas temperature**

An obvious loss associated with boiler operation occurs when the exhaust flue gas exits the boiler with an elevated temperature. A diagnostic measurement essential to boiler efficiency evaluation is the exhaust flue gas temperature. This measurement should be recorded at least daily and should be recorded with respect to boiler steam load and ambient conditions. Furthermore, the location of the sensing point is critical. The sensing location should be as close to the flue gas exit of the last point of heat exchange for the flue gas. In other words, if the boiler is equipped with a feedwater economizer, the temperature sensor should be located at the flue gas exit from the economizer. The idea is to obtain the true energy content of the flue gas stream in relation to the energy exchange processes within the boiler. An annual comparison should be

made between the current boiler flue gas temperature and previous temperatures with the boiler operating under similar conditions of steam loading and ambient conditions.

Flue gas exit temperature is affected by many factors, such as

- boiler load,
- boiler design,
- combustion-side heat transfer surface fouling,
- water-side heat transfer surface fouling,
- flue gas bypassing heat transfer surfaces because of failed boiler components, and
- excess air (possibly).

The next subsections of this text describe the usual ways in which these common factors affect flue gas temperature and how they can be managed.

#### **4.2.3.2.1 Boiler load**

Flue gas exit temperature is affected by boiler load (steam production); as boiler load increases, flue gas exit temperature generally increases. This is primarily because the amount of heat transfer surface within the boiler is fixed, which allows less heat transfer per unit mass of combustion products as the load increases.

Elevated flue gas temperature is indicative of elevated loss; therefore, it would appear that the boiler should be operated at low load to reduce stack losses. However, as boiler load is diminished, flue gas oxygen content must increase to maintain proper combustion. This serves to increase stack loss because of elevated excess air flow. Furthermore, shell losses increase in fraction of total loss for the boiler. Shell losses do not increase in magnitude as boiler load increases, but shell loss increases in percentage of total fuel energy input. (A later section of this text will describe shell losses.) As a result, most typical boilers will not experience significant improvement in efficiency as steam load is reduced.

Many boilers will experience a nonproportional greater increase in flue gas temperature rise when the boiler is operated at a load greater than 100% of design. This can result in significant losses and is the main component leading to efficiency reduction for boilers operating at greater than 100% of full load.

In summary, boiler load generally will affect flue gas exhaust temperature. This effect is essentially a design characteristic of the boiler with very little management capability for a given boiler. The main point is to recognize flue gas temperature does change with respect to boiler load and to account for this change when evaluating performance degradation. Therefore, flue gas temperature should be recorded with respect to boiler load as well as ambient temperature to allow an appropriate comparison of boiler operation.

#### **4.2.3.2.2 Boiler design**

The design of a boiler is key to overall steam generation efficiency. Heat transfer area and other design considerations are important factors in determining the amount of energy transferred from the flue gas. Obviously additional heat transfer area will in general equip a boiler to operate more efficiently (reduce flue gas exhaust temperature). The amount of heat transfer area is a design factor that carries economic consequences. Additional heat transfer surface requires additional expense.

From a management standpoint little can be done operationally to reduce the design component of stack loss once the boiler has been installed. Generally, improvements in this area take the form of installing additional heat recovery equipment. The most common forms of heat recovery

equipment are (1) feedwater economizer and (2) combustion air preheater. Both of these components are heat exchangers that extract energy from the flue gas. A feedwater economizer exchanges heat between the flue gas and feedwater prior to entering the boiler. A combustion air preheater exchanges heat between the flue gas and the combustion air entering the boiler.

Practical limits exist that dictate the maximum amount of energy that can practically be extracted from the flue gas. These limits arise from corrosion issues and result in a minimum (practical) flue gas temperature. This minimum flue gas temperature is significantly influenced by the corrosiveness of the flue gas. Sulfur content of the fuel is directly responsible for this limit if the fuel contains sulfur. Sulfur itself is a fuel, which reacts with oxygen to form sulfur oxide ( $\text{SO}_2$  or  $\text{SO}_3$ ). These chemicals react with water ( $\text{H}_2\text{O}$ ) to form sulfuric acid ( $\text{H}_2\text{SO}_4$ ), which is corrosive to many boiler components. Problems occur with this chemical when it condenses. Therefore, the flue gas must be maintained at a temperature greater than the dewpoint of sulfuric acid in the flue gas. Experience indicates that the corrosion rate can be reduced to safe limits if the temperature of the heat transfer surface is maintained above certain minimum values. These values correspond to the feedwater inlet temperature for economizers.<sup>4</sup> Figure 2 is a representation of the minimum metal temperatures for economizers.

If the fuel does not contain sulfur, the dewpoint of water vapor will be the temperature limit. This results because a carbonic acid corrosion potential exists although there is no sulfuric acid corrosion potential. Carbonic acid ( $\text{H}_2\text{CO}_3$ ) forms from a reaction between water and carbon dioxide ( $\text{CO}_2$ ).

Metallurgical technology exists that allows the flue gas to be cooled below the dew point of these chemicals and thus minimize corrosion. This technology is not considered in this analysis but should be investigated with equipment specialists.

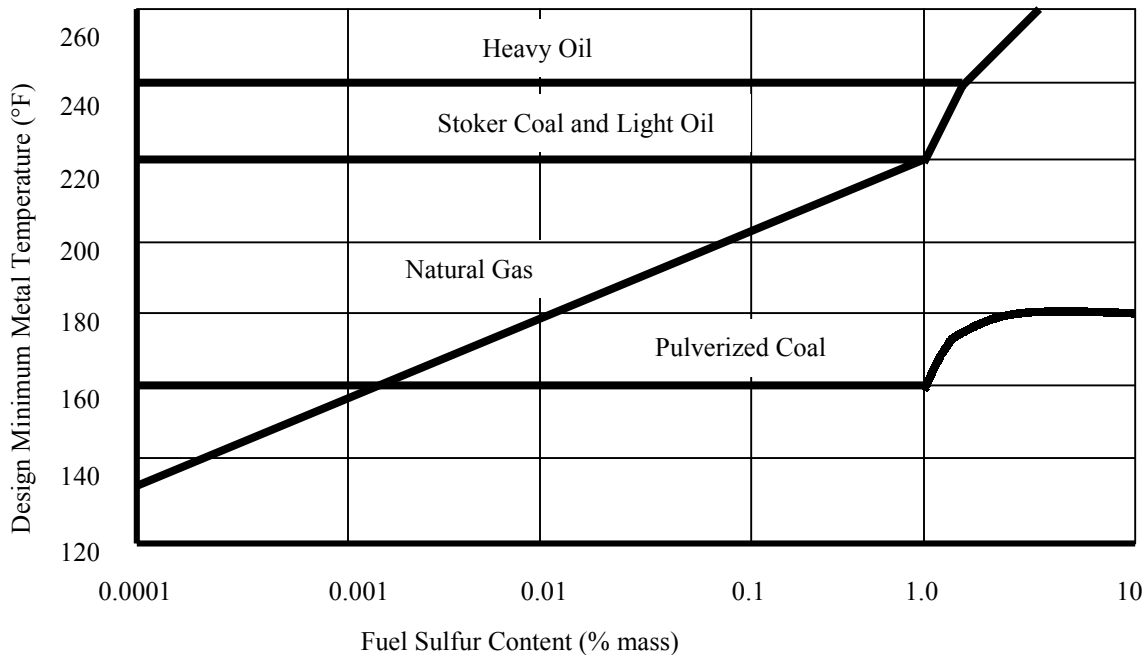

Fig. 2. Design minimum metal temperatures.

#### 4.2.3.2.3 Heat transfer surface fouling

A boiler is a large heat exchanger with a tremendous amount of heat transfer surface area. If the heat transfer surface becomes fouled, heat transfer will be reduced, and efficiency will suffer. Fouling can occur on the water-steam side of the boiler as well as on the combustion-flue-gas side of the boiler. The fouling mechanisms and management techniques vary for the deposit type.

Waterside fouling most commonly results from dissolved chemicals in the feedwater, which precipitate on boiler heat transfer surfaces. These “dissolved solids” are much more soluble in liquid water than in steam. Therefore, these chemicals enter the boiler with the feedwater, but they essentially do not leave the boiler with the steam; as a result they concentrate in the boiler water. If not removed with blowdown, these chemicals concentrate until the saturation limit is reached at which point precipitation occurs. The most detrimental form of precipitation with regard to heat transfer is a precipitant forming a layer of scale, which insulates the heat transfer surface.

Waterside fouling is addressed best by prevention. This is accomplished through makeup water treatment, condensate conditioning, chemical addition, and blowdown. Waterside fouling is generally a thin scale deposited at the boiler tube surface. Once the layer of scale has formed, two primary methods of removal are used: mechanical cleaning and chemical cleaning. Mechanical cleaning can involve water jet cleaning, which uses high-pressure water jets to scrub and dislodge the scale deposit. Brushes and other scrubbing devices are also used in this service. Chemical or acid cleaning acts to dissolve the deposit. All of these methods are obviously conducted while the boiler is out of service and should be completed by trained, experienced personnel.

Waterside fouling can contribute to tube failures. Many of the deposits are accelerated by increased heat flux; therefore, the “hottest” section of tubes can tend to scale more rapidly. As the scale layer forms, the tube is insulated at the inside tube surface, which allows the external surface to increase in temperature. The tube strength decreases as the temperature increases, and tube failures can result. Under-deposit corrosion can also occur resulting in tube failures.

Fireside fouling is generally most prevalent in solid fuel boilers when compared to fuel-oil and natural-gas-fired boilers. Solid fuels contain some amount of ash that generally remains in solid form throughout the combustion and heat transfer processes. Ash will form into fine particles that can be carried with the flue gas. As the ash-laden flue gas contacts boiler heat transfer surfaces, the ash can attach to the heat transfer surfaces. Similar to waterside scale deposits, fireside ash deposits insulate the heat transfer surfaces and result in reduced boiler efficiency in the form of increased flue gas temperature. Natural gas and light fuel oils carry essentially no ash load. Generally, No. 6 fuel oil (heavy fuel oil) has some component of ash, which provides a fouling potential. Fireside fouling can also promote corrosion and result in tube failures.

Fireside fouling is reduced by periodic off-line and on-line cleaning. Sootblowing is generally an effective method used to clean the combustion side of boilers that burn fuels with an ash component. Sootblowing is the use of a high-pressure steam jet sprayed onto the surface of the boiler tubes to dislodge the accumulated deposits. This can be a very effective cleaning method, which is conducted while the boiler is in service. Compressed air is used on some boilers as the blowing medium. The flue gas exit temperature should be monitored before and after the sootblowing operation to indicate performance. Sootblowing is also conducted with acoustic horns, which vibrate the deposit from the tube surfaces.

The sootblowers in the boiler are critical factors in maintaining the cleanliness of the boiler tubes. Sootblowers can be located throughout the boiler at any location prone to fouling. A method that can be employed to verify the effectiveness of the sootblowing operation is to monitor flue gas temperatures exiting the sootblower sections before and after the sootblowing event. The main factor indicating the effectiveness of the operation is the change in flue gas

temperature. If the sootblowing operation is necessary (i.e., the tubes are fouled), then the flue gas temperature should reduce after the sootblowing operation. Thermometers should be calibrated to ensure proper monitoring.

#### 4.2.3.2.4 Failed internal component

Boilers are designed with specific paths for the combustion gases to pass through. These paths are provided by internal baffles, which can fail. If a component fails, a significant loss can result. Figure 3 provides a depiction of how a failed internal baffle can result in a boiler loss. A failed internal component should obviously be repaired; however, the magnitude of the economic loss will dictate whether the boiler should be taken off-line immediately or repaired during a scheduled outage.

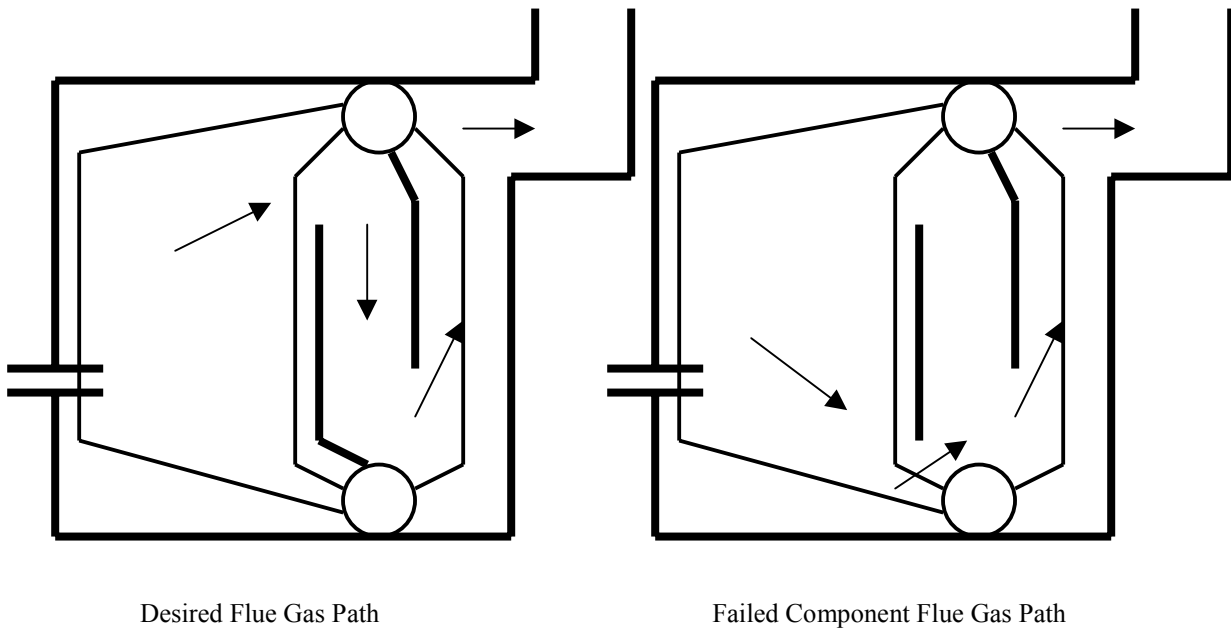

**Fig. 3. Flue gas path.**

#### 4.2.3.2.5 Efficiency improvement example

The example boiler initially operates with a flue gas exhaust temperature of 560°F (490°F net stack temperature) and is currently operating at 80% of the design steam load. One year ago under similar loading and ambient conditions, the boiler operated with an exhaust temperature of 460°F (390°F net temperature). The boiler is now operating with a flue gas oxygen content of 5.0%. The current boiler efficiency was determined in a previous section to be 79.2% with a combustion loss of 18.18%. The combustion loss for the operation 1 year before is given in Table 4, which also can be found in Appendix B. The previous combustion loss was 15.54%. During 1 year, the boiler efficiency has deteriorated from 81.9% to 79.2%. The approximate economic savings to be obtained by returning the efficiency to the previous level is provided below.

$$\phi = \frac{\eta_{\text{old}}}{\eta_{\text{new}}} = \frac{79.2\%}{81.9\%} = 0.967 \quad (25)$$



$$\sigma = \dot{K}_{\text{boiler}} (1 - \phi) = \$9,245,000/\text{year} (1 - 0.967) = \$305,000/\text{year} . \quad (26)$$

This is a significant potential savings to be obtained if the problem can be identified and rectified. The boiler operating cost, \$9,245,000/year, was determined from the savings calculated in Eq. (22).

Even if the flue gas temperature is reduced to the previous level (460°F), additional efficiency improvement can be implemented through the installation of flue gas heat recovery. The type of fuel is a major consideration in the selection of flue gas heat recovery equipment. The significant factors affecting the design of the heat recovery equipment are corrosiveness of the fuel and ash content of the fuel. The selection and design of a feedwater economizer or combustion air preheater should be completed by a competent professional. The initial evaluation of the potential savings opportunity can be conducted by an approximate analysis. For the example being used for this guide, No. 2 fuel oil will typically contain negligible amounts of sulfur and ash. This will allow a feedwater preheater to be designed to operate with a flue gas outlet temperature less than 300°F. If the flue gas temperature is reduced to 300°F, by recovering energy to the boiler feedwater, the combustion loss will reduce to 11.38% (assuming flue gas oxygen content remains 5%). Boiler efficiency will improve to approximately 86.0%. The approximate additional savings is calculated below.

$$\phi = \frac{\eta_{\text{old}}}{\eta_{\text{new}}} = \frac{81.9\%}{86.0\%} = 0.952 . \quad (27)$$

$$\sigma = \dot{K}_{\text{boiler}} (1 - \phi) = \$8,940,000/\text{year} (1 - 0.952) = \$426,000/\text{year} . \quad (28)$$

This too appears to provide a project with good economic potential. However, significant cost and downtime are required to install the economizer. Therefore, detailed evaluation is required to completely evaluate the project's potential. The boiler operating cost—\$8,940,000/year—was determined from the savings calculated in Eq. (26).

#### 4.2.4 Blowdown Loss

Boiler blowdown is essential for continued operation of any steam boiler. Reducing the loss associated with boiler blowdown is achieved through two avenues. First, blowdown rates are reduced through improved feedwater quality with the main focus on make-up water treatment and recycled condensate quality. Along with this is proper chemical treatment in the boiler. The second avenue centers on recovering the resident energy in the blowdown.

Boiler blowdown amount is typically controlled through the use of chemical analysis of the boiler water. Probably the most common control mechanism utilizes the measurement of boiler water conductivity, which is a gross indication of boiler water chemical concentrations. This measurement is repeatable and reliable, which makes it an excellent control measurement. Often a conductivity value is maintained in the boiler water by continuously modulating the amount of blowdown water removed from the boiler. Conductivity measurements should be supported by periodic boiler water chemical analysis.

Boiler water conductivity control is excellent to control blowdown rate; however, the actual flow of blowdown water is not known from the control scheme. To determine the magnitude of the loss associated with blowdown, the mass flow rate of blowdown must be known. Blowdown flow is typically not measured directly because of flowmeter difficulties. However, accurate estimates of blowdown amount can be obtained through chemical analysis of chloride, silica, or other chemical components when continuous blowdown is employed. Water treatment personnel

can generally provide the chemical analysis required to determine blowdown. Blowdown is typically expressed as a percentage of total feedwater flow.

Care must be given to evaluation of boilers using only intermittent blowdown. Intermittent blowdown can be very effective (and preferred) for the control and management of boiler water chemistry of relatively small-capacity, low-pressure boilers. Intermittent blowdown is accomplished one to three times each day and consists of releasing boiler water for only several seconds. This type of blowdown control allows the chemical constituents in the boiler water to concentrate until the blowdown event occurs. The blowdown event significantly reduces the chemical concentrations in the boiler water and allows continued operation. This control method will release more blowdown water than continuous control; therefore, in larger capacity boilers, continuous blowdown will generally be more economically attractive.

Blowdown amounts are generally less than 10% of total feedwater flow. However, 5% would be extraordinarily high for a system with high-quality water treatment systems. The correct blowdown amount for a given boiler is a function of steam pressure, feedwater purity, and chemical treatment program. The main factors to be controlled by blowdown are the chemical concentrations in the boiler. Typical chemical concentration limits for boiler water are provided in Table 5.<sup>6</sup>

**Table 5. Boiler water chemical limits**

Parameters	Boiler pressure (psig)					
	150	300	600	900	1,200	1,500
	Chemical concentration (mg/L)					
<b>TDS (maximum)</b>	4,000	3,500	3,000	2,000	500	300
<b>Phosphate (as PO<sub>4</sub>)</b>	30–60	30–60	20–40	15–20	10–15	5–10
<b>Hydroxide (as CaCO<sub>3</sub>)</b>	300–400	250–300	150–200	120–150	100–120	80–100
<b>Sulfite</b>	30–60	30–40	20–30	15–20	10–15	5–10
<b>Silica (as SiO<sub>2</sub>)</b>	100	50	30	10	5	3
<b>Total iron (as Fe)</b>	10	5	3	2	2	1
<b>Organics</b>	70–100	70–100	70–100	50–70	50–70	50–70

Each facility should work with the site water treatment expert to develop the most appropriate water treatment plan for the site. Poor water treatment can result in very damaging problems such as, scale formation, foaming, oxygen pitting, acidic condensate, and energy waste.

If the blowdown amount is known, the loss associated with blowdown can be estimated. The blowdown loss equation follows.

$$\lambda_{\text{blowdown}} = \frac{\text{Energy in the blowdown stream}}{\text{Total energy added to the boiler with fuel}} \quad (29)$$

$$\lambda_{\text{blowdown}} = \frac{\dot{m}_{\text{blowdown}}(h_{\text{blowdown}} - h_{\text{makeup}})}{\dot{m}_{\text{fuel}} \text{HHV}} \quad (100)$$

Equation (29) will provide the loss associated with boiler blowdown as a percent of total energy input with the fuel.

For the example boiler, the blowdown was determined by boiler water analysis to be 9% of feedwater flow. Feedwater flow was measured to be 109,890 lb<sub>m</sub>/h; 9% of the feedwater flow is

9,890 lb<sub>m</sub>/h. Blowdown and makeup water properties are found in Table 2. The calculation follows with the total energy added to the boiler with fuel provided by Eq. (14).

$$\lambda_{\text{blowdown}} = \frac{9,980 \text{ lb}_m/\text{h}(474.64 \text{ Btu}/\text{lb}_m - 28.07 \text{ Btu}/\text{lb}_m)}{161,971,000 \text{ Btu}/\text{h}} \quad (100)$$

$$\lambda_{\text{blowdown}} = \frac{4,456,768 \text{ Btu}/\text{h}}{161,971,000 \text{ Btu}/\text{h}} (100) = 2.8\% \quad . \quad (30)$$

Another way of communicating the same information is that more than  $4.4 \times 10^6$  Btu/h [the numerator of Eq. (30)] of input fuel energy is being lost as blowdown. The fuel cost determined previously was \$7.15/10<sup>6</sup> Btu. The calculation below identifies the approximate economic loss associated with boiler blowdown for the example boiler.

$$\Lambda_{\text{blowdown}} = \frac{\dot{E}_{\text{fuel}} \lambda_{\text{blowdown}} \kappa_{\text{fuel}} T}{100}$$

$$\Lambda_{\text{blowdown}} = 161,971,000 \text{ Btu}/\text{h} \left( \frac{2.8\%}{100} \right) \$7.15/10^6 \text{ Btu} (8,760 \text{ h}/\text{year}) \frac{10^6 \text{ Btu}}{1,000,000 \text{ Btu}} \quad (31)$$

$$\Lambda_{\text{blowdown}} = \$284,000/\text{year} \quad .$$

For the example boiler, 9% blowdown would be considered elevated even with a modest water treatment system. If the blowdown could be reduced to 5%, the savings would be approximately \$120,000/year. This savings estimate was determined by repeating the above calculations for a blowdown of 5%. The difference in blowdown loss ( $\Lambda_{\text{blowdown}}$ ) is the approximate savings opportunity.

The next area of discussion centers on recovery of the energy resident in blowdown. Blowdown is necessary for the continued operation of any typical steam boiler; therefore, it is beneficial to understand the mechanisms available to recover a portion of the energy in the blowdown. Two primary methods will be discussed here.

First, flash steam recovery is a potential efficiency improvement opportunity. As the blowdown exits the steam drum and decreases in pressure, a portion of the liquid blowdown flashes to steam. This steam is free from the impurities resident in the blowdown and can be used. The amount of flash steam increases as the pressure difference between the boiler pressure and the flash pressure increase. Generally, the blowdown stream is reduced in pressure and passed through a pressure vessel (flash tank). The flash tank serves as a separator to allow the remaining liquid blowdown to separate from the flash steam. The flash steam is piped into the low-pressure steam system or many times into the deaerator.

Second, a heat exchanger can be employed to transfer the energy in the blowdown to makeup water. Caution should be exercised in the choice of heat exchanger because the blowdown stream has a significant fouling potential. The heat exchanger must be capable of being cleaned.

The flash tank and heat exchanger can be used in combination to provide low-pressure steam and preheat makeup water. In the combined arrangement, blowdown water exiting the flash tank is passed through the heat exchanger. A steam system specialist should be contacted to analyze the opportunity associated with these projects. It is often difficult to implement this type of energy recovery system in systems employing intermittent blowdown.

#### 4.2.5 Shell Loss

Shell losses are categorized as the heat transfer (radiation and convection) losses from the boiler's external surface. A determination of *expected* radiation and convection losses can be obtained from the American Boiler Manufacturers Association (ABMA).<sup>7</sup> This association has provided data for the typical shell losses associated with water tube boilers. A gross representation of the ABMA expected shell loss graph for water tube boilers is provided in Fig. 4.

This general information indicates that most water tube boilers should have less than a 1.0% shell loss as related to total fuel input if the boiler is operating close to full load. This is the expected loss if there are no problems with the refractory or boiler cladding. The magnitude (Btu/h) of the shell loss does not change appreciably with respect to boiler load. As a result, if the loss is considered as a percentage of fuel input energy, the loss percentage increases as boiler load decreases.

Fire tube boilers typically have shell loss percentages much less than comparable capacity water tube boilers. In general this is because the external shell of a fire tube boiler is usually in thermal contact with boiling water (at relatively low temperature) rather than combustion gases at elevated temperatures. Therefore, the shell loss associated with a fire tube boiler is expected to be less than a typical water tube boiler of the same steam production capacity.

A general boiler shell analysis should be conducted to determine if there are areas where the refractory or insulation is in poor condition. This analysis can be completed with sophisticated thermal scanning equipment, infrared thermometers, or an excellent initial investigation can be completed by a visual and "gross thermal" inspection of the boiler surface. During this inspection, the main targets are "hot spots;" these areas usually indicate a problem associated with the internal refractory. The example boiler would be expected to experience a shell loss of approximately 0.8% of total fuel input energy. This was determined from Fig. 4.

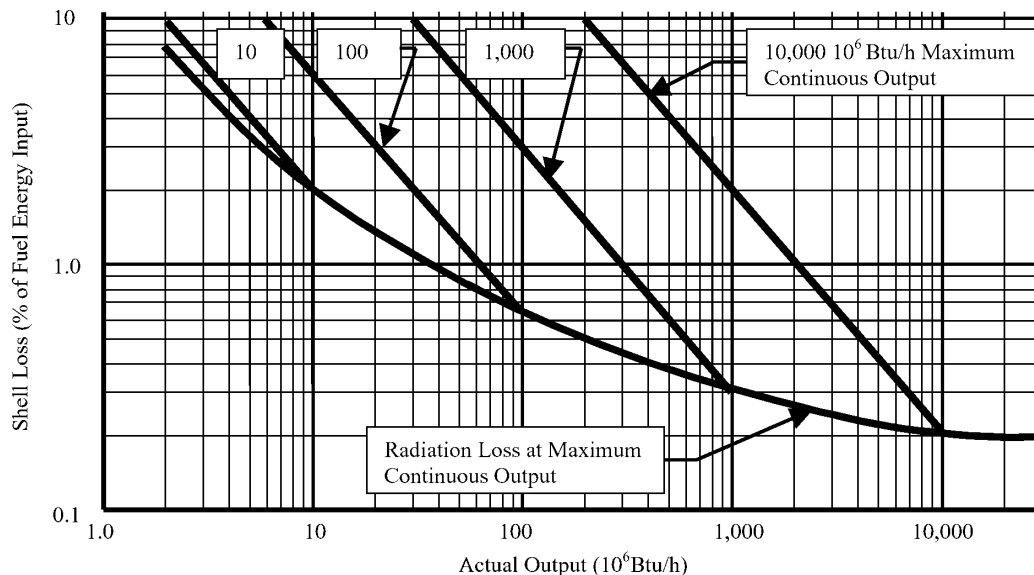

Fig. 4. ABMA typical shell loss.

#### 4.2.6 Unburned Fuel Loss

Coal and other solid fuel combustion presents many challenges to the operation and maintenance of a boiler. Unburned fuel or the combustibles content of the ash is a loss that is generally

negligible for other fuel types but it can be significant in coal-fired boilers. This discussion is not concerned with the partial combustion of fuel forming carbon monoxide in the flue gas but the amount of fuel remaining in ash unburned.

Ash content of coal varies widely from less than 5% to more than 20% of the total mass of the fuel. If a sample of ash is analyzed after the fuel has been burned, the amount of carbon can be measured in a laboratory. Once the amount of carbon in the ash is known, the loss to the system can be calculated. The equation to accomplish this is provided below.

$$\lambda_{\text{unburned fuel}} = \lambda_{\text{uf}} = \phi_{\text{uf}} \dot{m}_{\text{fuel}} \text{HHV}_{\text{carbon}} T \kappa_{\text{fuel}} \quad (32)$$

The factor  $\phi_{\text{uf}}$  is the fraction of fuel that is unburned as determined by the laboratory analysis. To complete the analysis, the amount of ash in the fuel must be known. This is supplied from a laboratory analysis as well. The equation for  $\phi_{\text{uf}}$  is provided below.

$$\phi_{\text{uf}} = \frac{m_{\text{uc}}}{m_{\text{ash}}} \left( \frac{m_{\text{ash}}}{m_{\text{fuel}}} \right), \quad (33)$$

where  $m_{\text{uc}}/m_{\text{ash}}$  is the fraction of unburned carbon in the ash sample, and  $m_{\text{ash}}/m_{\text{fuel}}$  is the fraction of ash in the original fuel sample.

The higher heating value of carbon,  $\text{HHV}_{\text{carbon}}$ , is used in Eq. (32) because most of the other fuel species are more volatile than carbon, and essentially carbon will be the only fuel species remaining in the ash. The higher heating value for carbon is 14,100 Btu/lb<sub>m</sub>.

Generally, unburned carbon losses are expected to be less than 0.5% of the total fuel input energy. An expected unburned carbon content would be less than 5% unburned carbon in the ash. Unburned carbon is a function of many factors with the major factors being related to combustion and fuel conditioning.

#### 4.2.7 Boiler Efficiency Summary

Boiler efficiency can be determined by many different methods. The two most common efficiency determinations used as benchmarks in industrial settings are boiler first law efficiency [direct efficiency, Eq. (10)] and indirect efficiency [Eq. (13)]. In theory both methods are evaluating the same performance characteristics of a boiler; the effectiveness of converting fuel energy into steam energy.

The example boiler was found to have a direct efficiency of 72.2% [Eq. (12)]. The indirect efficiency evaluation identified the primary losses associated with the boiler operation as stack losses, blowdown losses, and shell losses. Stack losses were determined to be 25.2% (Table 4). Blowdown losses were calculated to be 2.8% [Eq. (30)], and shell losses were provided from the ASME shell loss graph as 0.8% (Fig. 4). As a result, the indirect efficiency evaluation reveals an efficiency of 71.3%. This is very close agreement between methods.

### 4.3 BOILER LOADING

Boiler efficiency is not constant throughout the operating range of a typical boiler. Generally, boiler efficiency decreases significantly when the boiler is operating at less than 50% of its design load because of many factors; the main factors are increased excess air requirements to maintain complete combustion and constant magnitude shell losses. The upper end of the operating range generally presents a decrease in efficiency also because of increased flue gas exit temperature. Systems with multiple boilers should incorporate system controls designed to

operate the combined system at the maximum overall efficiency. Excess boiler capacity on-line can result in boilers operating at reduced efficiency. In contrast, insufficient boiler capacity on-line can significantly diminish reliability.

Many boilers are operated in an “on-off” or “load-unload” mode. This type of operation should be investigated from the standpoint of parasitic losses. Each time the boiler loads, the combustion control system purges the boiler with ambient air to remove any residual combustibles. This is required from a safety and operational standpoint. However, the purge air is absorbing energy from the water inside the boiler; therefore, it presents a loss to the boiler. A secondary loss occurs while the boiler is off-line. Any air allowed to draft through the boiler will absorb energy from the hot water. In general, a natural draft will result for most boilers. These parasitic losses should be considered in a detailed system analysis. The possibility of allowing boilers to operate in a modulation-off control mode may provide overall efficiency improvement.

#### 4.4 BOILER FUEL FLOW ESTIMATE

If individual fuel flow monitoring equipment is not resident on boilers, an estimate of boiler fuel flow can be developed by determining boiler efficiency by the indirect efficiency method, Eq. (13). This method assumes boiler efficiency is 100% minus the sum of the losses. The primary losses have been previously identified as shell losses, blowdown losses and stack losses.

$$\eta_{\text{indirect}} = 100\% - \lambda_{\text{shell}} - \lambda_{\text{blowdown}} - \lambda_{\text{stack}} \quad . \quad (34)$$

Other miscellaneous losses exist, but these are generally the main losses. In fact, the major loss associated with the boiler operation is typically stack loss. Therefore, indirect efficiency can be estimated from flue gas temperature and oxygen content. After an estimate of boiler efficiency has been obtained, the definition of boiler efficiency can be used along with steam production to estimate fuel flow. The equation follows.

$$\dot{m}_{\text{fuel}} = \frac{\dot{m}_{\text{steam}}(h_{\text{steam}} - h_{\text{feedwater}})}{\eta_{\text{estimate}} \text{HHV}} \quad . \quad (35)$$

Care should be given to account for efficiency expressed in fractional form for this equation and not a percentage. The estimate can be refined by determining estimates for radiation and convection loss as well as blowdown loss. These losses can be incorporated in the efficiency estimate. Radiation and convection losses can be estimated from ABMA information. Blowdown losses can be determined from the blowdown percentage and a modification of the blowdown loss equation, which was expressed as Eq. (29). The modified equation follows.

$$\lambda_{\text{blowdown}} = \frac{\dot{m}_{\text{blowdown}}(h_{\text{blowdown}} - h_{\text{makeup}})\eta_{\text{estimate}}}{\dot{m}_{\text{steam}}(h_{\text{steam}} - h_{\text{feedwater}})} \quad . \quad (36)$$

The efficiency estimate in the equation can be taken as indirect efficiency, considering only stack losses and radiation and convection losses. This calculation procedure can be very helpful in system evaluations.

#### **4.5 CALL TO ACTION—BOILER EFFICIENCY**

1. Determine boiler efficiency (%).
2. Investigate boiler shell for hot spots.
3. Determine boiler blowdown rate (% of feedwater flow, lb<sub>m</sub>/h).
4. Investigate feedwater quality improvement opportunities.
5. Investigate blowdown heat recovery opportunities.
6. Monitor flue gas oxygen content (%).
7. Monitor flue gas exhaust temperature with respect to boiler load, ambient temperature, and flue gas oxygen content (°F).
8. Monitor flue gas combustibles (ppm).
9. Evaluate unburned carbon loss (%).

## 5. EFFECTIVENESS OF RESOURCE UTILIZATION

### 5.1 OVERVIEW AND GENERAL PRINCIPLES

Analysis of the effectiveness of resource utilization focuses on determining if the energy resources associated with the steam system are being used most appropriately. Primary energy resources are, of course, steam and fuel. However, in many instances electricity and shaft power are primary components of the overall energy system. These energy resources can be significant aspects contributing to the overall economics, reliability, and efficiency of the site.

The main focus areas in this section of the survey guide follow:

1. Fuel selection
2. Steam system balancing
  - Vent steam
  - Combined heat and power
    - Backpressure turbine activities
    - Condensing turbine operations
3. Process integration (thermal energy recovery)

### 5.2 FUEL SELECTION

Boiler operating costs are directly influenced by fuel price. Fuel pricing can be time-dependent with many fuels changing significantly in price during the course of a year. Also, “firm” and “interruptible” pricing can provide significant price differences. Firm pricing would be for a guaranteed fuel supply, while interruptible pricing is usually a much lower price for customers who are willing to accept periodic interruptions in the fuel supply. Facilities purchasing fuel on an interruptible basis typically operate with a dual fuel capability. The primary fuel supplied to the boiler is the interruptible fuel, and a secondary moderately priced fuel is generally stored on site or supplied from a firm contract. There are no clear guidelines to follow in purchasing fuels; however, if the opportunity presents itself, many boilers can be equipped with dual fuel or multifuel capability relatively easily.

Operating a boiler with No. 2 fuel oil rather than natural gas will have little effect on the operating conditions of the boiler. The boiler should be capable of operating within the same flue gas oxygen content and essentially the same flue gas exit temperature irrespective of these fuels. The efficiency of the boiler will change because of the composition of the fuel; in other words, the stack loss will change.

However, changing from natural gas to No. 6 fuel oil will significantly impact the operation of the boiler as well as fuel storage and handling. These issues must be considered when investigating multifuel operation. Coal and wood combustion increase the fuel storage and handling issues tremendously. Fuels containing ash will significantly impact the operation of the boiler and the potential for fireside fouling. Furthermore, ash handling and abatement must be considered.

Environmental issues are of prime concern when considering multiple fuel supplies. The primary components of concern focus on opacity (visual or particulate emissions), sulfur oxides, and nitrous oxides. However, environmental issues concerning fuel storage and ash handling and removal can prove to be monumental as well. Supply or transportation of the fuel to the site can also be a critical concern.



### 5.2.1 Fuel Switch Example

The example boiler in this text is assumed to now be operating with a boiler efficiency of 79.8% and is burning No. 2 fuel oil. This boiler efficiency was determined in Sect. 4.2.3.1 and is in reference to a stack loss of 18.2%. The cost of No. 2 fuel oil is \$7.15/10<sup>6</sup> Btu as determined by Eq. (3) (\$1.00/gal). As an example, suppose the facility could purchase natural gas during specific periods of the year for \$5.00/10<sup>6</sup> Btu. The potential savings would be developed from an analysis comparing fuel cost and boiler efficiency. Boiler efficiency is included because if the fuel changes the efficiency of the combustion process will change. In general, blowdown losses, shell losses, and other miscellaneous losses will be unaffected by this change in fuel.

Stack loss will be affected by fuel switching, even if flue gas temperature and flue gas oxygen content remain constant. Interestingly the fuels generally considered “the best” result in the lowest combustion efficiencies. In other words, natural gas and light fuel oils will have greater stack loss than heavy fuel oils and coal for similar flue gas exit temperatures and excess air amount. This results in large part from the amount of hydrogen in the fuel. Hydrogen reacts in the combustion process to form water (H<sub>2</sub>O). This water is a major constituent of the exiting flue gas. Water is an excellent conveyor of energy, this is a reason steam is the predominant medium used in industry for energy transfer. The water formed in the combustion process conveys a significant amount of energy from the boiler as the flue gas exits the boiler. Therefore, in general as the hydrogen content of a fuel increases, the stack loss associated with the fuel will increase.

The savings associated with switching fuel type is determined by the calculation below. This calculation begins with Eq. (17) and incorporates the change in fuel price. Note that the energy added to the steam remains constant.

*Savings from fuel switching* =  $\sigma$  = *Initial operating cost* – *Final operating cost*

$$\sigma = \dot{K}_1 - \dot{K}_2 = \frac{\dot{E}_{\text{steam}}}{\eta_1} \kappa_{\text{fuel 1}} - \frac{\dot{E}_{\text{steam}}}{\eta_2} \kappa_{\text{fuel 2}} = \dot{E}_{\text{steam}} \left( \frac{\kappa_{\text{fuel 1}}}{\eta_1} - \frac{\kappa_{\text{fuel 2}}}{\eta_2} \right) . \quad (37)$$

In this example calculation the energy added to the steam has been provided in Eq. (15). Stack losses can be determined through the use of the natural gas stack loss table contained in Appendix B. Stack loss for this example is 22.65%, providing a boiler efficiency of 75.3% when blowdown and shell losses are considered (2%). The savings calculation of Eq. (37) is provided below.

$$\sigma = 116,929,000 \text{ Btu/h} \left( \frac{\$7.15/10^6 \text{ Btu}}{0.798} - \frac{\$5.00/10^6 \text{ Btu}}{0.753} \right) = \$271/\text{h} . \quad (38)$$

In other words, every hour of fuel switching has the potential of saving \$271, or 100 h of fuel switching results in \$27,100 of savings. The opportunities can be significant.

### 5.3 SYSTEM BALANCING

Balancing or matching the steam flows through the system with the thermal energy demands of the processes can present challenging problems. The challenges arise when system managers strive to maximize the use of energy resources. This text will focus on a few common areas of interest; however, effective management of energy resources can and does take many forms. Areas of primary concern in most steam systems center on capturing the maximum amount of

thermal energy resources. This typically involves activities such as elimination of vent steam and effective use of energy resources.

Elimination of vent steam is a relatively simple target. Vented or discharged steam is an easily identified loss, which results in a marked target. That is not to say elimination of vent steam is necessarily easy, but the target is readily identifiable. Effective use of energy resources can be more elusive because the losses may not be as blatant as a steam plume rising from a facility. Generally effective resource utilization involves activities incorporating steam turbine drives or other energy conversion devices to capture resources effectively. The following sections will provide some general discussions in these areas.

### 5.3.1 Vent Steam

Any steam discharged from the system through nonuseful means is an obvious loss from the system. Some steam discharges are necessary; deaerator vents are a principal example. Steam must be discharged from the deaerator to allow oxygen and carbon dioxide to exit the system. Although the discharge is necessary, it represents a loss from the system. A common mechanism resulting in vent steam is an overpressurized steam system. This may occur as a result of steam turbine drives discharging more steam to a low-pressure header than the low-pressure steam users are demanding, or a control system may not be allowing effective system control. In this situation, the excess steam is simply vented to maintain an acceptable pressure in an individual steam header.

The loss associated with vent steam is obvious. Fuel was purchased to generate steam, and the steam was not utilized or was only partially utilized and was then lost to the environment. This loss results from the steam system being “out of balance.” The approximate loss associated with vent steam can be calculated if the flow rate is known. The following equation provides the *approximate* loss.

$$\lambda_{\text{vent}} = \frac{\dot{m}_{\text{vent}}(h_{\text{vent}} - h_{\text{makeup}})K_{\text{fuel}}T}{\eta_{\text{boiler}}} \quad (39)$$

As an example, 1000 lb<sub>m</sub>/h of steam is being vented from a 25-psig header. The boiler efficiency has been determined to be 80%. The vent steam occurs continuously, 8760 h each year. The loss is calculated below for a fuel cost of \$7.15/10<sup>6</sup> Btu. The steam is assumed to be saturated and the makeup water supply is 70°F.

$$\lambda_{\text{vent}} = \frac{1,000 \text{ lb}_m/\text{h}(1,169.58 \text{ Btu}/\text{lb}_m - 28.07 \text{ Btu}/\text{lb}_m) \$7.15/10^6 \text{ Btu}(8,760 \text{ h}/\text{year})}{0.80} = \$89,372/\text{year} \quad (40)$$

This is only an approximation of the loss because the details of the steam system operation have not been considered. If the vent steam passes through a steam turbine prior to exiting the system, then some resource capture has taken place. Other factors also influence the analysis; however, this calculation demonstrates that vent steam is a significant loss from the system and should be eliminated or the energy recovered. Note that a 1-in.-diam orifice will pass 1000 lb<sub>m</sub>/h of 25-psig steam.

The primary goal when investigating vent steam is to eliminate it; if the vent is necessary (deaerator vent), then recovery should be investigated. This can be a difficult task due to the reasons for the vent occurrence. Often excessive steam turbine discharge is the reason for the

venting. This problem may be difficult to remedy in a cost-effective manner because it may involve replacing steam-turbine-driven equipment with electric-motor-driven equipment. In other words, turbines should be taken out of service to eliminate the excess low-pressure steam. Generally, to accomplish this, motor-driven equipment must be placed into service to drive the components previously driven by turbines. If the motor-driven components are resident in the system, the solution is relatively simple. However, if these drives are not resident in the system, significant cost can be incurred for a new installation.

Piping distribution problems are another common cause for vent steam. Low-pressure steam can be required for process service in one location of the facility, while steam turbines are discharging low-pressure steam at a separate location in the facility. These two areas can be connected with piping of insufficient size to transfer the steam between the areas. Therefore, the local header at the turbine discharge might be overpressurized and venting, while the process demand at the other end of the distribution system has an insufficient supply of steam. The steam supply header might need to be revised to allow the effective transfer of the steam.

### 5.3.2 Combined Heat and Power

Most industrial facilities require both thermal energy and electrical energy for general operations. Many of these facilities can combine the generation of thermal energy and the generation of power (electrical or shaft energy), which results in a very efficient energy conversion process. A typical fossil-fuel-fired utility power generation station will operate with a fuel to useful energy conversion efficiency of less than 40%. Industrial facilities that combine the generation and use of thermal and electrical resources can achieve fuel to useful energy conversion efficiencies near 60%. The primary reason for this dramatic increase in performance is that industrial facilities have a need for thermal energy. The utility power station rejects a significant amount of thermal energy to the environment (approximately 60% of the total input fuel energy) because electrical energy is the only useful product from the facility. An industrial facility can utilize the thermal energy in a manufacturing process.

A system that combines the generation and use of thermal and power resources is commonly termed a “combined heat and power system” or a “cogeneration system.” Cogeneration is the production of multiple energy supplies from one energy source. Probably the most familiar cogeneration system is a boiler-steam turbine system. This system receives fuel to produce steam, and the steam is passed through a turbine to produce electrical (or shaft) power. The exhaust steam from the turbine is supplied to processes requiring thermal energy. This is only one of many forms of cogeneration. The most common arrangements used in industrial combined heat and power systems are

- boiler-steam turbine,
- combustion turbine-heat recovery steam generator,
- combustion turbine-heat recovery steam generator-steam turbine (combined cycle), and
- internal combustion reciprocating engine-heat recovery unit.

Resource utilization analysis of a cogeneration facility can quickly become complicated; however, operational savings in this area can be tremendous. A thorough understanding of the steam distribution system and the steam users is essential to properly evaluate resource utilization effectiveness. The first step in the analysis is to develop a system schematic, which is a simple description of the steam system that may take the form of Fig. 5.

Known steam flow rates should be incorporated into the steam system information. Boiler outlet flows, process steam demands, turbine flow rates, and pressure-reducing valve steam flows are vital pieces of information in completing the analysis. This information will be used to

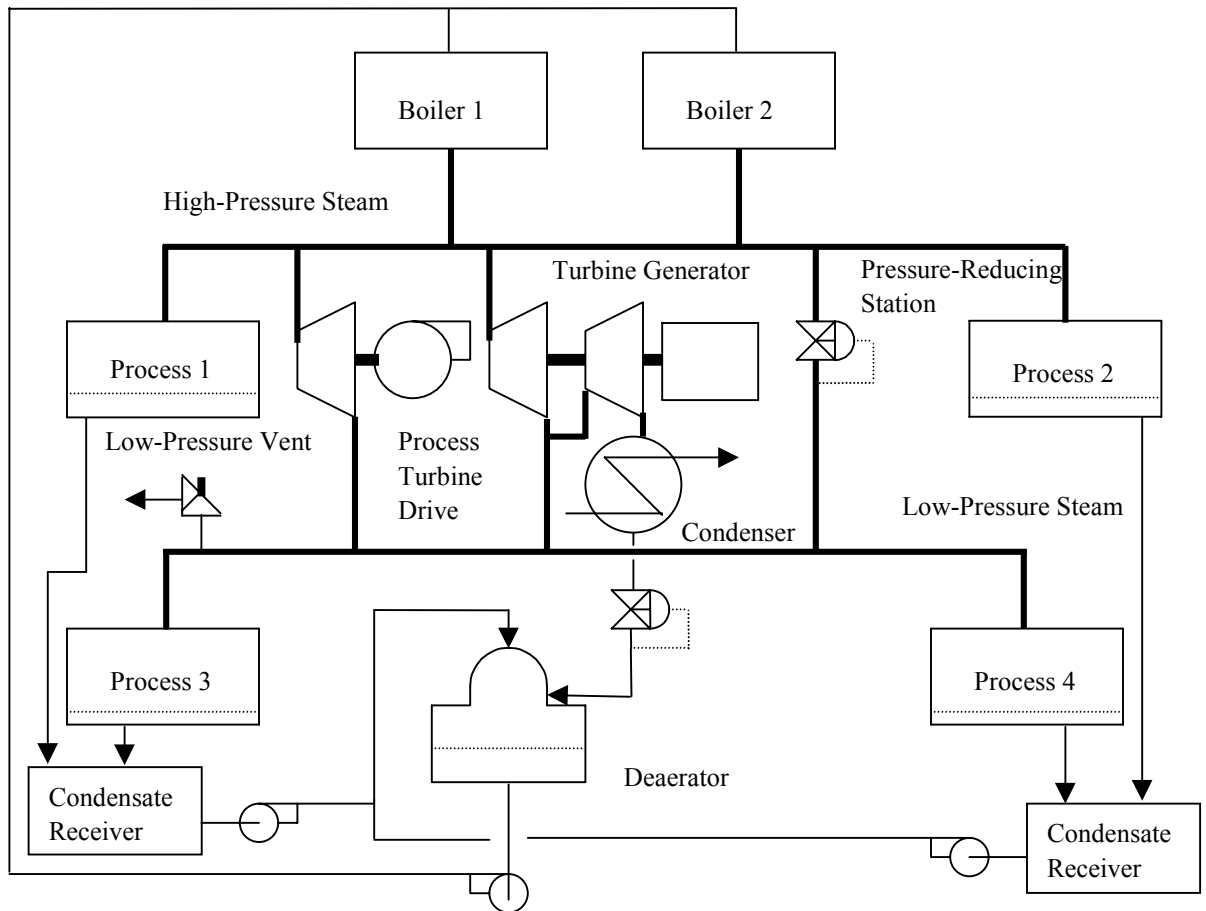

**Fig. 5. General steam system schematic.**

develop a steam system mass balance, which indicates the main steam flows throughout the system. Pressure-reducing valves and steam vents should be equipped with continuous flow monitoring to enable management of the energy resource.

Most multipressure steam systems are equipped with steam-turbine-driven equipment and pressure-reducing stations that operate in parallel. These two components are used in conjunction to provide the low-pressure steam demands in a cogeneration facility. Generally, in these systems the flow of steam through the pressure-reducing valves should be minimized. This is the case as long as the incremental cost of offset electricity is greater than the cost of fuel. In other words, the cost to produce shaft power from a steam turbine is less than the purchased cost of electricity. Furthermore, there must be a use for the turbine exhaust steam. If the exhaust steam is vented or if it is discharged to a condenser where no useful benefit is derived, the economics are significantly altered. Analysis of these conditions is the focus of the following sections.

### 5.3.2.1 Steam turbine efficiency

Boiler efficiency, fuel unit cost, and electrical unit cost are primary components in the analysis of a combined heat and power system. Systems operating with steam turbines are significantly influenced by turbine efficiency as well. Steam turbine efficiency is typically expressed as isentropic efficiency. A very important point of distinction between turbine efficiency and the

now familiar boiler efficiency is that turbine efficiency describes how well mechanical energy is developed from thermal energy. Boiler efficiency describes how much energy has been “lost” to nonuseful purposes from the boiler. The inefficiency of the turbine is not “lost” from the system; it has remained in the steam although some usefulness has been destroyed.

Isentropic efficiency is a comparison of the actual shaft power export of the turbine to that of an ideal, isentropic (or perfect) turbine.<sup>8</sup> The equation for isentropic efficiency,  $\eta_{\text{isentropic}}$  of a turbine section is provided below.

$$\eta_{\text{isentropic}} = \frac{\text{actual work}}{\text{isentropic work}} = \frac{\dot{W}_{\text{actual}}}{\dot{W}_{\text{isentropic}}} = \frac{\dot{m}_{\text{steam}}(h_{\text{inlet}} - h_{\text{exit}})_{\text{actual}}}{\dot{m}_{\text{steam}}(h_{\text{inlet}} - h_{\text{exit}})_{\text{isentropic}}} = \frac{(h_{\text{inlet}} - h_{\text{exit}})_{\text{actual}}}{(h_{\text{inlet}} - h_{\text{exit}})_{\text{isentropic}}}, \quad (41)$$

where  $h$  designates the enthalpy of the steam entering and exiting the turbine. This equation has been developed by assuming that kinetic and potential energy changes are negligible and heat transfer is negligible. These are good assumptions for typical steam turbines.

Isentropic exit conditions are assumed to occur at the same pressure as the actual turbine operation. The term “isentropic” denotes “constant entropy.” Therefore, with the inlet conditions known (entropy), the isentropic exit entropy is known. Thermodynamic properties can be obtained for the isentropic exit conditions, knowing the exit pressure and entropy values. Isentropic work is the maximum theoretical work output of the turbine, the output of a perfect turbine. Isentropic efficiency is typically expressed (as most efficiencies are) as a percent. Industrial steam turbine isentropic efficiencies range from less than 25% to slightly over 80%. Isentropic efficiency has a significant effect on the economic evaluation of a steam turbine system.

Steam turbine performance is also commonly expressed in terms of a “steam rate.” Steam rate is an expression of the amount of steam flow required to produce a specific amount of shaft power output from the turbine. The typical units of steam rate are pound mass per kilowatt-hour or pound mass per horsepower-hour.

Steam turbine efficiency should be monitored to ensure effective use of the steam resource. Turbines that do not exhaust saturated steam can be evaluated from temperature and pressure measurements taken at the turbine inlet and outlet. These measurements allow the actual enthalpy values to be determined for the inlet and outlet of the turbine. These values can be used in Eq. (41) along with the isentropic exit enthalpy to determine isentropic efficiency.

If the turbine exhausts saturated steam, then efficiency measurements are difficult to obtain. Steam enthalpy cannot be determined by temperature and pressure measurements of saturated steam. Temperature and pressure of saturated steam are not independent. A throttling calorimeter can be employed to obtain saturated steam measurements.<sup>9</sup> However, turbine exhaust pressure must be significantly greater than atmospheric pressure or a vacuum system must be employed to allow the instrument to function properly. Also, the steam sample must be representative of the bulk steam flow.

Generally, steam turbines discharging saturated steam must utilize power export measurements along with steam flow measurements to evaluate efficiency. If the turbine is coupled to an electric generator, the power output can be measured; however, if the turbine is driving a process component, then a determination of export power is difficult.

Poor efficiency can be a result of many factors. Some of the more common ones are

- turbine design,
- turbine load,
- silica deposits on turbine blades, and
- blade erosion and damage.

Small steam turbines are often equipped with valves, which allow the turbine to operate efficiently at part load. These valves are used to isolate a portion of the steam flow path. This allows the inlet control valve to open further reducing the throttling losses of the turbine. The valves are generally operated manually and should be either fully open or fully closed; they are generally not meant to throttle the steam. If a turbine consistently operates at reduced load, these hand valves can be closed to improve the operating efficiency of the turbine. This will result in reduced steam flow for the same power output. This can aid in alleviating vent steam flows.

One final general note is presented; a steam turbine is inherently a variable-speed device. Therefore, a steam turbine can be utilized as a prime mover served by a “low-cost” energy supply, and it can take advantage of the variable-speed efficiency improvements normally afforded to variable-speed electric motors.

### **5.3.2.2 Backpressure turbine operation**

A question arising frequently in steam system investigations relates to the comparison of passing steam through a pressure-reducing valve or through a steam turbine to supply a low-pressure steam demand. The most appropriate analysis of the economic benefits of operating the steam turbine uses a systems approach. The information of primary importance to the analysis is

- incremental electric cost,
- incremental fuel cost,
- steam turbine efficiency,
- steam flow,
- steam properties, and
- boiler efficiency.

The term “incremental electric cost” relates to the rate structure or tariff applied to electrical purchases at the facility. In particular, the actual economic impact of any change in electrical consumption is the incremental cost. Often the price of electricity is dependent on the amount of electricity consumed, the rate of electrical consumption, as well as the time of use. Most electrical tariffs for industrial sites carry fixed charges, which do not change with respect to electrical consumption.

To describe the benefits of operating a steam turbine, an example is investigated. The investigation considers a facility capable of operating under two different scenarios. The analysis focuses on a process component, represented as a pump. This component can be driven by an electric motor or a steam turbine. The system also has a need for low-pressure steam. The first operating arrangement investigated utilizes the steam turbine to drive the process pump and supply the low-pressure steam demand. The second arrangement utilizes a pressure-reducing valve to supply the low-pressure steam, and electricity is purchased to drive the pump. In both instances high-pressure steam is produced in the boiler. Figure 6 is a simplistic representation of the system.

The example analysis provided here does not attempt to explain electric rate structures but merely utilizes a fixed electric cost for simplicity. This may not reflect the actual conditions at a

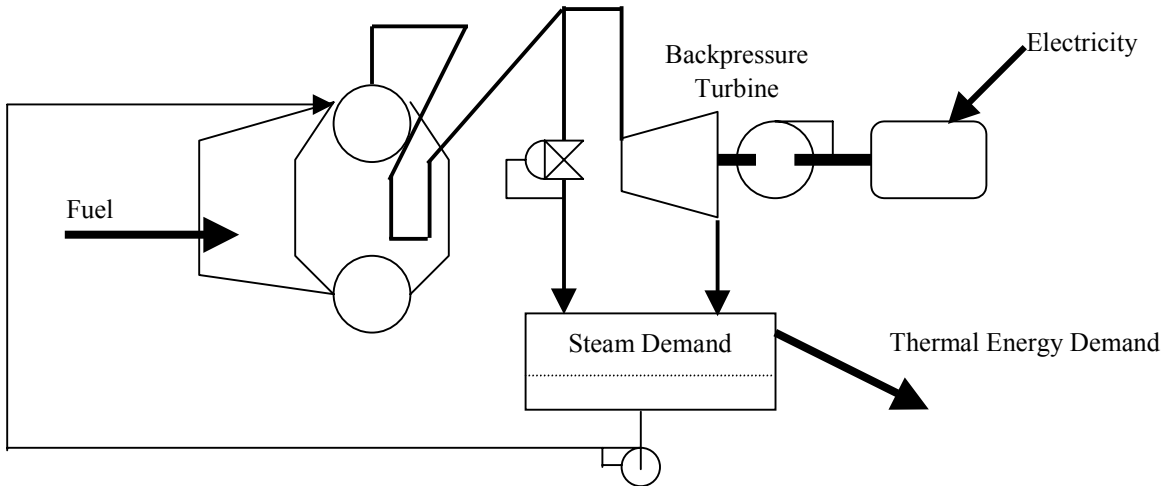

**Fig. 6. Steam turbine vs pressure-reducing valve example.**

given site. The same discussion can be applied to fuel pricing; however, in general fuel pricing is less complicated than electrical pricing.

High-pressure steam is produced in the boiler and is supplied to the steam turbine or the pressure-reducing valve. Steam exhausted from these components is supplied to the low-pressure user. For the example analysis, the fuel unit price is \$7.15/10<sup>6</sup> Btu, and the electrical unit cost is \$0.060/kWh. High-pressure steam conditions for this example are 600 psig and 750°F at the boiler outlet. The turbine and pressure-reducing valve export steam at 200 psig. Condensate is discharged from the steam user and is supplied to the system at 0 psig and 180°F (subcooled liquid). This is a simplified analysis; however, the main factors are incorporated; in other words, the economics will not change significantly for a typical steam system.

The example begins with the steam turbine in operation and the pressure-reducing valve receiving no steam flow. In this example the steam turbine is operating with a steam flow of 30,000 lb<sub>m</sub>/h, which corresponds to the boiler output steam flow. The operating cost of this system is determined by the fuel consumption of the boiler as calculated below.

$$\dot{K}_{\text{fuel}} = \kappa_{\text{fuel}} \frac{\dot{m}_{\text{steam}}(h_{\text{steam}} - h_{\text{feedwater}})}{\eta_{\text{boiler}}} T \quad .$$

$$\dot{K}_{\text{fuel}} = \$7.15/10^6 \text{ Btu} \left[ \frac{30,000 \text{ lb}_m/\text{h}(1,378.95 \text{ Btu}/\text{lb}_m - 147.91 \text{ Btu}/\text{lb}_m)}{0.85} \right] 7,884 \text{ h/year} \quad . \quad (42)$$

$$\dot{K}_{\text{fuel}} = \$2,449,000/\text{year} \quad .$$

Steam properties used in the example can be found in Table 2 or common thermophysical properties reference materials.<sup>1-3</sup> Boiler efficiency,  $\eta_{\text{boiler}}$ , is assumed to be 85%, and the period of operation is taken as 90% of a year (7884 h/year). The operating cost identified above is the total operating cost of the system because no electricity is required to operate the process pump. This operating cost will be compared to a system operating without the turbine, which will require the purchase of electricity to drive the process pump. The amount of electricity purchased will be the same as the amount of shaft energy produced by the turbine. Therefore, a turbine analysis is required.

The turbine discharges steam with a temperature of 621°F, a pressure of 200 psig, and an enthalpy of 1,331.88 Btu/lb<sub>m</sub>. Turbine isentropic efficiency is calculated below.

$$\eta_{\text{isentropic}} = \frac{(h_{\text{inlet}} - h_{\text{exit}})_{\text{actual}}}{(h_{\text{inlet}} - h_{\text{exit}})_{\text{isentropic}}} = \frac{1,378.95 \text{ Btu/lb}_m - 1,331.88 \text{ Btu/lb}_m}{1,378.95 \text{ Btu/lb}_m - 1,261.28 \text{ Btu/lb}_m} = 0.40 \quad . \quad (43)$$

The isentropic efficiency of the turbine is 40%, which is typical for small industrial steam turbines. Shaft energy output of the turbine is determined in the following calculation.

$$\begin{aligned} \dot{W}_{\text{shaft}} &= \dot{m}_{\text{turb}}(h_{\text{in}} - h_{\text{out}}) = 30,000 \text{ lb}_m/\text{h} (1,378.95 \text{ Btu/lb}_m - 1,331.88 \text{ Btu/lb}_m) \\ \dot{W}_{\text{shaft}} &= 1,412,000 \text{ Btu/h} \left( \frac{1 \text{ kWh}}{3,413 \text{ Btu}} \right) = 413 \text{ kW} \quad . \end{aligned} \quad (44)$$

The example continues by investigating the operating cost associated with powering the pump with the electric motor and supplying low-pressure steam through the pressure-reducing valve. The shaft power required by the pump is assumed to be the same as the turbine output, 413 kW. The electrical requirement of the motor will be greater than this because of the inefficiency of the motor. Motor efficiency data can be obtained from motor manufacturers, and DOE has a software package containing a database of motor information.<sup>10</sup> In this simplified analysis, motor efficiency,  $\eta_{\text{motor}}$ , is assumed to be 90%. The cost associated with purchasing the required amount of electricity is calculated below.

$$\begin{aligned} \dot{K}_{\text{elec}} &= \kappa_{\text{elec}} \dot{W}_{\text{elec}} T \left( \frac{1}{\eta_{\text{motor}}} \right) \\ \dot{K}_{\text{elec}} &= \$0.060/\text{kWh} (413 \text{ kW}) 7,884 \text{ h/year} \left( \frac{1}{0.9} \right) \\ \dot{K}_{\text{elec}} &= \$217,000/\text{year} \quad . \end{aligned} \quad (45)$$

Often this is reported as the potential savings associated with operating the steam turbine (\$217,000/year) because this is the avoided electrical purchase. However, most steam systems are supplying low-pressure steam to heat transfer loads. The energy content (enthalpy) of the steam exiting the pressure-reducing station will be greater than the enthalpy of the steam exiting the turbine. This is a result of the turbine converting a portion of the steam energy into shaft energy. A thermodynamic analysis of the pressure-reducing valve indicates that the process is a constant enthalpy process (isenthalpic). Therefore, the temperature of the steam exiting the pressure-reducing valve would be approximately 712°F, with an enthalpy of 1,378.95 Btu/lb<sub>m</sub>. As a result, the amount of steam (mass flow) needed by the low-pressure demand will decrease when the pressure-reducing valve is used. The actual amount of steam required is determined by an energy balance comparison between the two operating conditions. The amount of energy supplied to the low-pressure steam demand during the steam turbine operation is calculated below.

$$\begin{aligned} \dot{Q} &= \dot{m}_{\text{steam}}(h_{\text{turbine steam}} - h_{\text{condensate}}) = 30,000 \text{ lb}_m/\text{h} (1,331.88 \text{ Btu/lb}_m - 147.91 \text{ Btu/lb}_m) \\ &= 35,519,100 \text{ Btu/h} \quad . \end{aligned} \quad (46)$$



This energy flow must be the same for both operating modes; as a result, the steam flow through the pressure-reducing valve can be calculated.

$$\dot{m}_{\text{steam}} = \frac{\dot{Q}}{(h_{\text{prv steam}} - h_{\text{condensate}})} = \frac{35,519,100 \text{ Btu/h}}{(1,378.95 \text{ Btu/lb}_m - 147.91 \text{ Btu/lb}_m)} = 28,852 \text{ lb}_m/\text{h} \quad (47)$$

Fuel required by the boiler reduces with the decreased steam demand. Boiler fuel requirement is calculated as follows.

$$\dot{K}_{\text{fuel}} = \kappa_{\text{fuel}} \frac{\dot{m}_{\text{steam}}(h_{\text{steam}} - h_{\text{feedwater}})}{\eta_{\text{boiler}}} T$$

$$\dot{K}_{\text{fuel}} = \$7.15/10^6 \text{ Btu} \left[ \frac{28,852 \text{ lb}_m/\text{h}(1,378.95 \text{ Btu/lb}_m - 147.91 \text{ Btu/lb}_m)}{0.85} \right] 7,884 \text{ h/year} \quad (48)$$

$$\dot{K}_{\text{fuel}} = \$2,355,500/\text{year} \quad .$$

The total operating cost associated with the pressure-reducing station operation is the combination of the boiler fuel cost and the electrical cost.

$$\dot{K}_{\text{prv}} = \dot{K}_{\text{fuel}} + \dot{K}_{\text{elec}} = \$2,355,500/\text{year} + \$217,000/\text{year} = \$2,572,500/\text{year} \quad (49)$$

The cost savings associated with operating the steam turbine is the difference in the operating cost of the pressure-reducing valve and the turbine.

$$\sigma = \dot{K}_{\text{prv}} - \dot{K}_{\text{turbine}} = \$2,572,500/\text{year} - \$2,449,000/\text{year} = \$123,500/\text{year} \quad (50)$$

Therefore, in this analysis the fuel and electric savings associated with operating the steam turbine rather than the pressure-reducing station is approximately \$123,500/year.

One factor impacting actual savings that was not considered in the analysis was steam turbine maintenance requirements. Steam turbine maintenance requirements vary from site to site, depending mainly on steam conditions and rigor of preventative maintenance programs. The costs associated with turbine maintenance should be incorporated into the analysis on a site-by-site basis.

Steam turbine efficiency is critical to the economics of this type of system. In general, monitoring steam turbine performance is not a difficult endeavor. Steam turbines exporting superheated steam can be evaluated by investigating steam pressure and temperature at the turbine inlet and outlet. If accurate temperature and pressure measurements are made, the isentropic efficiency can be determined. Efficiency evaluations should be performed periodically and compared to previous operating conditions to determine if maintenance procedures are required. If the turbine is operating with saturated steam conditions at the outlet, evaluation of performance becomes much more difficult.

Many industrial facilities desuperheat the steam discharged from pressure-reducing valves and from steam turbines. The desuperheater operation does not significantly impact the analysis, but it should be incorporated if it exists. The analysis procedure remains the same as identified here; the thermal energy supplied to the steam demand is determined by the mass flow of steam

exiting the desuperheater and the temperature and pressure of the steam. These properties will be the same for turbine operation and for pressure-reducing station operation.

Care should be given to the selection of the driven component. If the turbine is coupled to a process component (e.g., pump, compressor, etc.), then the steam flow through the turbine cannot be controlled by the low-pressure steam demand. In these situations, elimination of steam flow through pressure-reducing stations is almost impossible. However, if the turbine is coupled to an electric generator and the site has an alternate supply of electricity, the steam flow through the turbine can be controlled by the low-pressure steam demand. This type of operation can eliminate steam flow through pressure-reducing stations. However, additional inefficiencies are introduced because the generator is not perfectly efficient.

### 5.3.2.3 Condensing turbine operation

Combined heat and power systems must continually “balance” thermal energy (steam) demands and shaft energy (electrical or power) demands. Many systems occasionally (or continually) require more shaft energy than can be supplied by a steam turbine discharging low-pressure steam to a *useful* thermal demand. An effective “balancing component” is a condensing steam turbine.

A condensing steam turbine is a turbine discharging steam to a subatmospheric pressure condenser; that is, a condenser operating with a pressure less than atmospheric pressure (vacuum). This type of turbine is fundamentally no different than a backpressure turbine. A condensing turbine does not discharge 100% condensate. In fact, the actual amount of condensate discharged from a condensing turbine is minimal. Typically, the mass flow rate of vapor is much greater than 90% of the combined mass flow rate of liquid and vapor.

A system with a backpressure turbine operating in conjunction with a condensing turbine can provide great flexibility in balancing a system. This arrangement can allow the useful thermal demand to be supplied through the low-pressure turbine discharge and the shaft energy demand to be supplied through the combined power output of the backpressure turbine and the condensing turbine. An arrangement of this type is represented in Fig. 7.

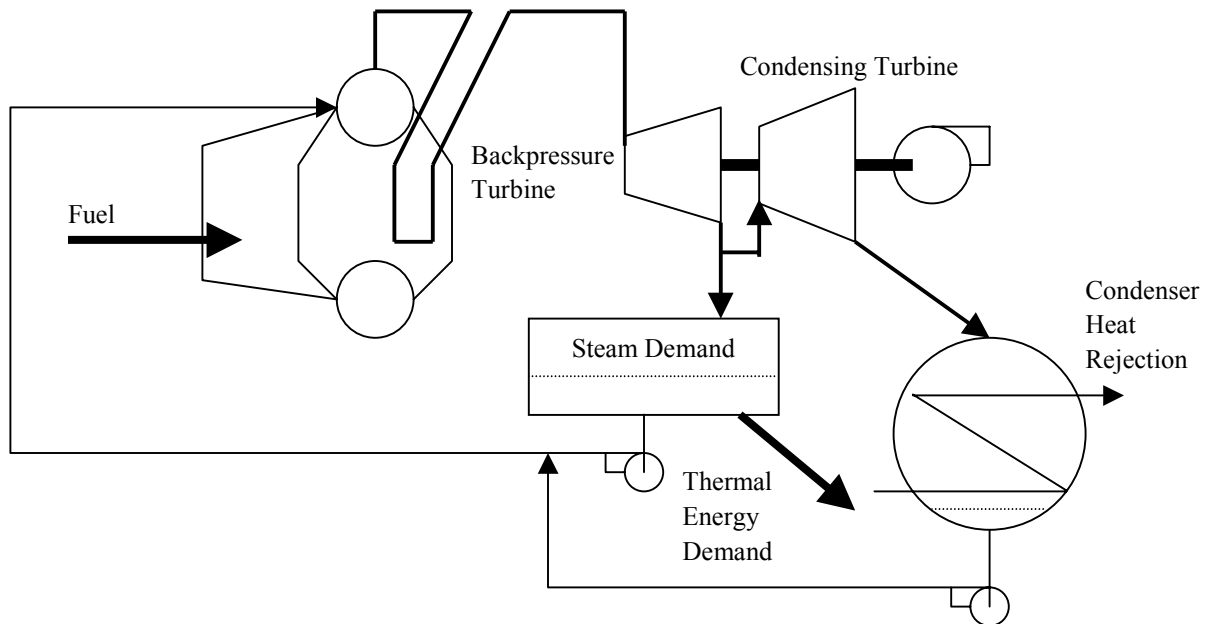

Fig. 7. Extraction condensing turbine arrangement.

Steam turbines discharging to subatmospheric condensers can be an excellent system-balancing component. However, the economic viability of their operation is very dependent on the electrical offset costs, fuel costs, boiler efficiency, and the turbine efficiency. Turbine efficiency is a major factor impacting performance. The economics of operating a condensing steam turbine are generally far less favorable than operating a backpressure turbine when the exhaust steam from the backpressure turbine is used for a specific purpose. Typically, the thermal energy resident in the steam exhausted from a condensing steam turbine is discharged to the environment and serves no useful purpose but actually provides thermal pollution. As a result, the “cost” of the shaft power from a condensing turbine includes the steam energy extracted in the turbine as well as the steam energy rejected in the condenser. An example is provided here to demonstrate the basic analysis involved in determining the operating economics of a typical condensing turbine. The analysis is approximate and simplified, but it provides an excellent first-order estimate of the economic characteristics associated with operating a condensing turbine.

The basic system parameters used in the backpressure turbine analysis are used again in this example. High-pressure steam is produced in the boiler and is supplied to the condensing steam turbine. Steam exhausted from the turbine enters a surface condenser operating at 1.5 in. of mercury absolute (0.73 psia or 28.5 in. of mercury vacuum). The condensate exiting the condenser is assumed to be saturated liquid at the pressure of the condenser. For the example analysis, the fuel unit price is \$7.15/10<sup>6</sup> Btu, and the electrical unit cost is \$0.060/kWh. High-pressure steam conditions for this example are 600 psig and 750°F at the boiler outlet. The turbine operates with an isentropic efficiency of 70%.

The example begins with the steam turbine in operation receiving 50,000 lb<sub>m</sub>/h of steam flow. The turbine steam flow corresponds to the boiler output steam flow for this simplified analysis. The operating cost of this system is determined by the fuel consumption of the boiler as calculated in Eq. (51).

$$\dot{K}_{\text{fuel}} = \kappa_{\text{fuel}} \frac{\dot{m}_{\text{steam}} (h_{\text{steam}} - h_{\text{feedwater}})}{\eta_{\text{boiler}}} T$$

$$\dot{K}_{\text{fuel}} = \$7.15/10^6 \text{ Btu} \left[ \frac{50,000 \text{ lb}_m/\text{h} (1,378.95 \text{ Btu}/\text{lb}_m - 59.56 \text{ Btu}/\text{lb}_m)}{0.85} \right] 7,884 \text{ h/year} \quad (51)$$

$$\dot{K}_{\text{fuel}} = \$4,375,000/\text{year} .$$

Steam properties in the example can be found in common thermophysical property reference materials.<sup>1-3</sup> Boiler efficiency,  $\eta_{\text{boiler}}$ , is assumed to be 85%, and the period of operation is taken as 90% of a year (7884 h/year). The operating cost identified above is the total operating cost of the system because no electricity is required to operate the process component. This operating cost will be compared to a system operating without the turbine, which will require the purchase of electricity to drive the process component. The amount of electricity purchased will be the same as the amount of shaft energy produced by the turbine. Therefore, a turbine analysis is required.

The turbine inlet conditions are known, as well as the turbine isentropic efficiency. Through use of common thermophysical property data, the isentropic exit enthalpy can be determined. For this example, the isentropic exit enthalpy is 892.15 Btu/lb<sub>m</sub>. Equation (41) can be utilized to determine the actual outlet enthalpy. The calculation is provided below.

$$\eta_{\text{isentropic}} = \frac{(h_{\text{inlet}} - h_{\text{exit}})_{\text{actual}}}{(h_{\text{inlet}} - h_{\text{exit}})_{\text{isentropic}}} = \frac{1,378.95 \text{ Btu/lb}_m - h_{\text{exit}}}{1,378.95 \text{ Btu/lb}_m - 879.53 \text{ Btu/lb}_m} = 0.70 \quad . \quad (52)$$

$$h_{\text{exit}} = 1,029.36 \text{ Btu/lb}_m \quad .$$

Shaft energy output of the turbine is determined in the following calculation.

$$\dot{W}_{\text{shaft}} = \dot{m}_{\text{turb}}(h_{\text{in}} - h_{\text{out}}) = 50,000 \text{ lb}_m/\text{h} (1,378.95 \text{ Btu/lb}_m - 1,029.36 \text{ Btu/lb}_m) \quad (53)$$

$$\dot{W}_{\text{shaft}} = 17,479,424 \text{ Btu/h} \left( \frac{1 \text{ kWh}}{3,413 \text{ Btu}} \right) = 5,121 \text{ kW} \quad .$$

The example continues by investigating the operating cost associated with powering the process load with an electric motor. The shaft energy required by the process component's motor is assumed to be the same as the turbine output, 5121 kW. In this simplified analysis, motor efficiency,  $\eta_{\text{motor}}$ , is assumed to be 90%. Motor efficiency reference data can be obtained from manufacturers or DOE.<sup>10</sup> The cost associated with purchasing the required amount of electricity is calculated below.

$$\dot{K}_{\text{elec}} = \kappa_{\text{elec}} \dot{W}_{\text{elec}} T \left( \frac{1}{\eta_{\text{motor}}} \right)$$

$$\dot{K}_{\text{elec}} = \$0.060/\text{kWh} (5,121 \text{ kW}) 7,884 \text{ h/year} \left( \frac{1}{0.9} \right) \quad (54)$$

$$\dot{K}_{\text{elec}} = \$2,692,000/\text{year} \quad .$$

A comparison of the fuel and electrical energy costs associated with the two operating conditions indicates that operating the process component with purchased electricity is much more cost-effective than operating the condensing steam turbine. The cost savings associated with operating an electric motor rather than a condensing steam turbine is provided below.

$$\sigma = \dot{K}_{\text{turbine}} - \dot{K}_{\text{electricity}} = \$4,375,000/\text{year} - \$2,692,000/\text{year} = \$1,683,000/\text{year} \quad . \quad (55)$$

### 5.3.2.3.1 Steam turbine condenser pressure

Steam turbine condenser pressure significantly impacts the effectiveness of a condensing steam turbine. As condenser pressure decreases, the power output of the turbine increases for the same steam flow rate. This is true within the operating range of the turbine.

To maintain condensing turbine performance, condensing pressure must be minimized. The primary factors commonly leading to elevated condenser pressure are

- fouled condenser heat transfer surface,
- noncondensable gas accumulation in the condenser,
- elevated cooling water inlet temperature, and
- reduced cooling water flow.

Heat transfer surface fouling can result from many factors: soluble salt precipitation, biological growth, and suspended solids accumulation. All of these factors are associated with the cooling water flow to the condenser. Many condensers incorporate on-line cleaning systems, which clean the waterside heat transfer surfaces by passing cleaning objects through the water passages to mechanically remove fouling debris. Periodic off-line cleaning may be required for tenacious deposits.

Noncondensable gases traveling with the steam will pass through the turbine and enter the condenser. Once in the condenser they must be removed, or they will affect the heat transfer activities in the condenser, which in turn will impact turbine performance. Noncondensable gases can also enter through leaks in the low-pressure sections of the turbine and the condenser. As the concentration of noncondensable gases increase, the total pressure of the steam and noncondensable gases will increase. Therefore, the turbine will be operating with an elevated discharge pressure. This also impacts the heat transfer characteristics within the condenser, reducing the heat transfer capability. Noncondensable gases must be removed. The most common methods of removal are steam jet ejectors and mechanical vacuum pumps. Both of these methods remove vapors from the condenser vapor space.

If the cooling medium increases in temperature, the exhaust steam from the turbine will condense at an increased temperature. The condensing steam will condense at the corresponding saturation pressure, which will be increased as well. Similarly, if the cooling medium flow is reduced, its temperature rise will increase. This increase will result in an increase in condensing steam temperature and pressure.

#### **5.4 PROCESS INTEGRATION**

When energy normally lost from the system can be captured or recovered, a net savings to the system results. Heat recovery from process units is an excellent opportunity for economic improvement. Hot process fluids can exchange heat with steam system fluids. Common components utilized in this service are

- heat recovery steam generators,
- feedwater preheaters, and
- combustion air preheaters.

Energy recovery can be accomplished from the steam system to manufacturing processes as well. As an example, a relatively hot contaminated condensate stream can exchange thermal energy with a process fluid before the condensate is discharged to the sewer system.

#### **5.5 STEAM SYSTEM PRESSURE**

Thermodynamic steam cycle efficiency increases as boiler pressure increases. This is true for systems utilizing steam turbines to produce shaft power. However, increasing steam pressure may not be the most advantageous activity if the system is not a combined heat and power system. In fact, if a boiler is supplying steam for heat transfer purposes only, then lowering the steam pressure may increase system efficiency. Reducing steam pressure impacts several aspects of the steam system. The primary factors will be introduced here.

Boiler efficiency can improve as a result of reducing steam generation pressure. As the steam pressure is reduced, the boiling temperature of the water in the boiler decreases. This increases the heat transfer to the boiler water, which increases the boiler efficiency. The efficiency improvement will be realized through a reduction in flue gas temperature.

There are, of course, limits to this activity. Reducing steam generation pressure reduces the density of steam generated in the boiler. This promotes increased boiler carryover, which can be detrimental to the steam system. Furthermore, flue gas temperature limits must be maintained to avoid corrosion in the flue gas passages. A detailed investigation should be conducted to determine the direct impact of reducing steam pressure on an individual boiler.

Additionally, system losses can be reduced through a reduction in steam pressure. Steam leaks experienced in the system will reduce in flow as the steam pressure is reduced. For example, if steam pressure is reduced from 130 to 100 psig, the leak rate will reduce more than 25%.

Heat transfer loss from piping will diminish in saturated steam systems as steam pressure is reduced. Utilizing the same pressure reduction as noted above (130 to 100 psig), the heat transfer loss from the insulated piping surface will reduce more than 5%.

Limitations exist in the distribution system as well. As the steam density is reduced, the steam velocity in the distribution system must increase to supply the same thermal energy to the various loads. Increased velocity increases the frictional losses throughout the system, and insufficient steam supply may result.

Heat exchangers throughout the system may also suffer. The heat exchangers will receive steam at reduced temperature, which can result in reduced heat transfer to products. In other words, reducing boiler steam pressure can improve system efficiency, but the effects of reduced pressure on the system must be thoroughly investigated.

## **5.6 CALL TO ACTION—EFFECTIVENESS OF RESOURCE UTILIZATION**

1. Develop a system schematic.
2. Develop a system mass and energy balance.
3. Investigate alternative fuels.
4. Monitor steam flow through vents and pressure-reducing stations.
5. Monitor backpressure turbine efficiency and operation.
6. Monitor condensing turbine efficiency and operation as well as condenser pressure.
7. Completely understand the electrical rate structure.
8. Evaluate the position and need of turbine hand valve operation.
9. Investigate the effect of changing the current boiler operating pressure.

## 6. STEAM DISTRIBUTION SYSTEM LOSSES

### 6.1 OVERVIEW AND GENERAL PRINCIPLES

The *Steam Distribution System Losses* category of a steam system assessment focuses on many different areas of the steam distribution system. The focus areas typically take the form of

- steam leaks,
- heat transfer loss through insulation,
- condensate loss, and
- flash steam loss.

These areas are fundamental in the field of energy management and generally result in attractive economics when savings opportunities are identified. All of these areas are essential to the continued efficient operation of any steam system.

### 6.2 STEAM LEAKS

Steam is obviously an expensive utility for which significant economic losses can result when steam is lost from the system through leaks. Typically, an energy survey reveals that reducing steam leaks is a significant area of potential savings for industrial facilities. Two main types of failures result in steam leaks: (1) pipe failures and (2) steam trap failures. Generally, steam trap failures account for a large portion of the leaks within a facility. Steam leaks from pipe failures can also be a major source of steam loss from a facility; however, these are generally eliminated from a safety standpoint. Steam trap failures are more difficult to observe than pipe failures, especially in closed condensate systems. A maintenance program based on finding and eliminating steam leaks is essential to the efficient operation of a steam system.

#### 6.2.1 Pipe Failures

Steam piping components fail as a result of improper design, corrosion, external factors, and many other reasons. From an energy analysis standpoint, pipe failures must be eliminated because they are a direct waste of the fuel resources. Generally, safety concerns are a major driving factor in the repair of steam piping failures. However, energy loss can help justify the maintenance expense when safety is not an issue. Basically, the loss associated with a steam leak is identical to that of vented steam. The equations required to obtain an estimate of the economic loss were provided in the Sect. 5.3.1 of this guide.

Note that if steam is being vented from a header for control purposes and steam is leaking from a pipe failure in the same header system, savings may not exist when the leak is repaired. The amount of leaking steam will most probably exit the vent if the pipe is repaired. Therefore, it is essential to properly balance the steam system.

Generally, the most effective pipe repairs are conducted when the system is out of service and depressurized. This provides the maintenance crew with the best access to the failed component. However, many circumstances arise which dictate that the system cannot be taken out of service for an extended period of time. If the magnitude of the loss is sufficient or it poses a safety hazard, the most appropriate repair may be an on-line repair. These repairs should only be completed by trained professionals. Several companies specialize in these efforts.

The steam leak repair procedure is generally decided based on the cost of the work. If the magnitude of the steam loss were known, the repair procedure selection might become clearer.

However, steam loss through a leak is difficult to determine. Generally, if the order of magnitude of the leak were known, this would be sufficient to plan the repair strategy. Several theoretical and empirical methods have been developed to provide a gross estimate of the steam loss. Table 6 provides the approximate flow of steam through a sharp-edged orifice.

**Table 6. Steam leak rates**

Hole diameter (in.)	Leak rate (lb <sub>m</sub> /h) at steam temperature of 500°F						
	Steam pressure (psig)						
	50	100	150	200	250	300	350
1/8	23	41	59	77	96	119	134
1/4	91	163	235	308	382	478	536
3/8	206	366	529	693	860	1,075	1,207
1/2	366	651	940	1,232	1,528	1,912	2,145
3/4	822	1,465	2,115	2,773	3,438	4,302	4,826
1.00	1,462	2,605	3,761	4,929	6,112	7,648	8,580
1.25	2,285	4,071	5,876	7,702	9,551	11,949	13,406
1.50	3,290	5,862	8,462	11,091	13,753	17,207	19,305

Table 6 was developed from a compressible flow analysis. This analysis agrees well with leak flow measurements. The analysis is somewhat tedious and complex, which makes utilizing this type of analysis cumbersome for estimating steam leaks. However, several empirical relationships have been developed that agree well with actual leak flow measurements. One of these relationships is Napier's equation.<sup>5</sup> This simple relationship is provided below.

$$\dot{m}_{\text{steam}} \approx (51.43)A_{\text{orifice}}P_{\text{steam}} \quad (56)$$

where, the mass flow rate of steam is provided in pound mass per hour,  $A_{\text{orifice}}$  is to be taken in square inches, and  $P_{\text{steam}}$  in pounds per square inch absolute. Care should be exercised in the use of this approximation because it was developed for a "well-rounded converging" orifice. A sharp-edged orifice will experience a flow of approximately 60% of this "well-rounded" flow. Equation 56 is applicable to saturated steam only. Additional simplified calculation methods are provided in Ref. 5.

This discussion presents the idea that estimating steam leaks is a straightforward task. This is the case if the leak to be estimated is a well-rounded orifice. However, only on rare occasions is a leak a well-rounded orifice. Therefore, the calculation method presented falls very short. Unfortunately, no good, broadly applicable method is available to estimate leak flows. On a positive note, generally only an order of magnitude estimate is required, and estimates can often be conducted utilizing calculation methods or other approximations.

Another method, which is cumbersome if many leaks are encountered but is accurate, is to actually measure the flow of steam. This can be accomplished through inexpensive means with pitot tubes or other types of flow measurement devices. Flow measurement can be applied to a few leaks, and other leaks can be compared to the known leak to obtain an order of magnitude estimate.

### 6.2.2 Steam Traps

Steam traps are vital components in most steam systems. They are designed to remove condensate from the steam distribution piping and heat exchange equipment. They also remove



noncondensable gases, which impede heat transfer and result in corrosion. System debris, improper sizing, and improper application are common causes of steam trap failure. Steam traps can fail in different modes. Two main failure modes result in significant economic impact. A failed-open steam trap allows “live” steam to discharge from the system, a steam leak. Steam traps may also fail closed, which allows condensate to backup into the equipment drained by the trap. If this is a process heat exchanger, the product will not receive the energy intended. Water hammer can also result, which can damage piping components. A well-maintained steam system will typically experience a 10% trap failure in a 1-year period. This can translate into significant losses to the system.

To minimize the loss associated with steam trap failures, a concerted effort must be applied to managing the steam trap population. A steam trap management program should incorporate the following activities:

1. Train personnel.
2. Locate and identify every trap.
3. Assess the operating condition of every trap at least annually.
4. Develop and maintain a trap database.
5. Respond to assessment findings.

Steam trap assessment should be conducted by personnel with knowledge in the operation and selection of steam traps. Therefore, training is critical to the success of the management program. The steam trap assessment should cover

- trap operation,
- trap selection (type and size),
- trap installation, and
- condensate return.

#### **6.2.2.1 Steam trap operation**

Determining if the steam trap is operating properly is a primary concern in the management effort. This can be a difficult task, especially in systems with closed condensate return systems. A closed condensate return system is one in which the trap discharges into a piping system. This piping system conveys the trap discharge to condensate collection components located throughout the system. In other words, visual inspection of the trap discharge is not easily accessible.

Further complicating steam trap analysis is the fact that steam traps have varying failure modes. The two most noticeable are failed-closed, passing no condensate or steam, and failed-open, passing live steam. If a trap is failed-closed, condensate will backup into the system. A heat exchanger with a failed-closed steam trap will allow no heat transfer to take place. This failure will generally be discovered by process personnel because the process component will not be performing.

A failed-open steam trap can potentially pass a significant amount of steam, which becomes an energy loss to the system. Leaking traps, which release steam to a lesser degree than failed completely open, are also a common failure mode.

Steam trap evaluation should be completed at least annually. Several methods are used to evaluate steam trap performance. The most common methods are visual, acoustic, thermal, and component. None of the methods provide perfect results, and generally trap operation is best analyzed by utilizing a combination of methods. These primary investigation methods will be outlined in the following paragraphs.

Visual investigation techniques observe the steam trap output. In closed condensate systems, this requires valves located in the trap discharge piping to isolate the trap discharge from the

remaining condensate return system. Also a valve is required to allow the trap to discharge to the atmosphere for inspection. Many times the capability to observe the trap discharge is not built into the system, and other methods must be utilized. Even if visual inspection of the trap discharge is available, difficulties arise. For this investigation method to be effective, the surveyor must be familiar with the discharge conditions of the various types of traps encountered. A thorough understanding of steam trap operation does not ensure an accurate analysis of trap performance. A gross failure of a steam trap, blowing or blocked, is generally relatively easy to identify. However, the volume flow of flash steam generally makes it very difficult to distinguish between a properly operating trap and a failed trap.

Thermal analysis of steam trap operation investigates the approximate temperature of the fluid entering and possibly exiting the steam trap. To properly utilize this method, the operation of the steam trap must be understood, and the steam system operating pressure must be known. Even if these operating parameters are known, evaluation problems exist. As an example, if a thermostatic trap is operating properly, it will subcool the condensate before the trap opens to discharge. Therefore, steam pressure must be known to provide the saturation temperature of the condensate. Also the degree of subcooling required for the given trap to open must be known; that is, the difference between the actual trap opening temperature and the saturation temperature of the steam. Different trap types will operate under different temperature constraints.

Acoustic monitoring of steam traps is an investigation method that incorporates listening to the trap operation. This can be accomplished by sonic or ultrasonic methods. Evaluating steam trap operation based on the sonic signature also requires knowledge of the trap operation. Background noise and a similarity in the sound of live steam and flash steam passing through a trap hamper the effectiveness of this method.

In general, effective steam trap evaluation requires multiple methods of investigation. Identification of the gross errors (blowing or blocked) is in general easier than identification of minor failures. The time and expertise requirements associated with utilizing these methods has prompted steam trap manufacturers to develop trap monitoring components. Typically, these monitoring components incorporate multiple evaluation techniques or variations of the above mentioned evaluation techniques to analyze steam trap operation. These components take two basic forms. One evaluation method fits each trap with a sensor that continually monitors the operation of the trap. Another type incorporates a portable device, which determines the thermal and acoustic signal of the trap and compares that to a data base containing the thermal and acoustic signature of a properly operating trap of the same type and model. These methods can provide excellent results; however, there is an initial equipment cost.

An indirect method investigates condensate receiver vents. If a steam trap is failed-open, steam will be passing into the condensate receiver and out the vent. When excessive vent steam is observed, the general area of the failed trap can be identified. Care should be used in this approach because most steam traps will discharge some flash steam when they are operating properly. Therefore, operators should be searching for excessive vent steam or changes in vent steam amount.

### **6.2.2.2 Steam trap selection**

Improper steam trap selection can lead to trap failure and poor component performance. This guide is not intended to serve as a steam trap selection and sizing guide; these activities are beyond the scope of this text. This text is serving to provide general information.

There are basically five types of steam traps (with some variation):

1. thermostatic,
2. open float,

3. closed float,
4. thermodynamic, and
5. orifice.

Some traps combine two or more trap types to enhance operation. Steam traps serve in many different applications. The nature of the application will many times dictate the type of steam trap most appropriate for the operation. Steam trap selection can make a significant impact on the function of the steam trapping system. Some common trapping applications are highlighted in the following paragraphs.

Steam traps that serve main steam headers and lateral headers are in place for two primary functions. First, traps serve to drain air (noncondensable gases) and large quantities of condensate during startup of the system. Second, header traps remove any condensate formed during normal operation. These are two very different operating conditions, especially if the steam system normally operates with superheated steam conditions. In this instance, the condensate load during normal operations will be minimal or none. Often the most appropriate practice is not to try to size the header drain traps for both services because they are vastly different and can result in improperly sized traps. Therefore, a common practice is to charge a steam header in a “supervised” manner and physically bypass the steam traps until the header has sufficiently heated. The primary goal, for startup and normal operation, is to remove condensate immediately from the piping. Condensate allowed to remain in the piping increases the probability of damaging water hammer. Water hammer occurs when relatively high velocity steam “picks up” a slug of liquid and transports it downstream at high velocity. This slug of liquid travels downstream until it encounters an obstruction, most often a bend in the pipe. The forces unleashed on the piping can be extremely destructive, even to the point of failing the pipe. Therefore, condensate should be removed immediately upon formation when draining headers.

Heat exchangers are generally significant components in steam systems. Heat exchangers perform best when condensate is removed immediately upon formation. Liquid condensate resists heat transfer much greater than saturated steam. Furthermore, the energy available for heat exchange in condensate is miniscule in comparison to condensing steam. Therefore, immediate removal of condensate from heat exchangers is usually a primary goal. Release of noncondensable gases is also a common function of heat exchanger steam traps. As a result, a steam trap should be chosen for these applications, which will remove condensate immediately and will provide good noncondensable gas removal capabilities.

Steam tracing is another common steam trap application. The primary object of steam tracing is to offset the insulation losses associated with a piping system. In general, steam tracing will not add significant thermal energy to a process stream but merely allows the process stream to maintain temperature by not experiencing heat transfer losses to the surroundings. Often size and weight of a trap serving a steam tracing application are important because of the method of installation. Usually the installation is small tubing passing throughout the facility. Often the traps will be exposed to the ambient, and in colder climates freezing is an issue. Therefore, the trap chosen should be resistant to freezing.

Multiple trap types will satisfactorily serve a given application with one type providing an advantage over the others, and some types being inapplicable. For example, if the service is a main header condensate drain for normal operation, an inappropriate type would be a thermostatic trap. This is because the trap requires the condensate to subcool before the trap will open. This can allow condensate to backup into the steam system and result in water hammer. In contrast, the remaining trap types all can possibly serve the application well. If, in this application, the steam is superheated, care must be given to use of the open float type trap because superheated steam can boil away the sealing condensate inside the trap and result in a trap open and passing live steam.

Steam trap manufacturers should be consulted for the most appropriate trap for specific applications.

Poor steam trap performance can result from undersized or oversized traps. Therefore, care should be given to determining the appropriate trap capacity for an application. Trap capacity is affected by the differential pressure across the trap. Many times trap capacity is limited because the condensate return system has elevated pressure. Often increased condensate system pressure occurs because the condensate piping is of insufficient capacity to transmit the condensate discharged into it. Many times condensate systems are designed without considering that most steam traps will discharge some flash steam. This steam must travel through the condensate system. Also, failed-open steam traps can overload the condensate system with excessive steam flow. Steam trap manufacturers are an excellent source of information in this area. Most manufacturers provide detailed selection guides as well as installation descriptions.

### **6.2.2.3 Steam trap installation and condensate return**

During the routine inspection of each steam trap, the installation of the trap as well as condensate return issues should be addressed. Steam trap piping installation can significantly degrade steam trap performance. Inappropriate piping can result in a vapor seal keeping the trap from receiving condensate. Many other impairments can result from poor piping installation. Each trap manufacturer supplies recommended piping installations for each trap type. These recommendations should be followed.

Each trap installation should be investigated to determine if condensate is being captured and returned to the steam system. In those installations where condensate is being collected, the return system should also be investigated to determine if it is operating properly.

### **6.2.2.4 Steam trap loss estimation**

A major difficulty in implementing a steam trap management plan is in determining the savings opportunity associated with replacing a failed steam trap. Failed-closed traps are not presenting an energy loss to the system. The savings opportunity of replacing failed-closed traps is dependent on the effect of not providing energy to the desired component (typically product throughput).

Failed-open steam traps can pass a significant amount of steam; however, it is difficult to determine the loss accurately. In general all that is needed is an order of magnitude estimate of the loss. Some general information concerning determination of steam flow through openings has been provided in Sect. 6.2.1. These methods are applicable here in limited fashion. Care must be given to the possible failure modes and the fact that the calculation methods are based on a known orifice size. If the trap is failed and is partially blocking the orifice, the calculation must be modified accordingly. Accurate evaluation of the modification can be impossible. However, note that an order of magnitude estimate is generally the desired result of the analysis.

### **6.2.2.5 Steam trap management summary**

As stated previously, to minimize the loss associated with steam trap failures, a concerted effort must be applied to managing the steam trap population. A steam trap management program should incorporate the following activities:

1. Train personnel.
2. Locate and identify every trap.

3. Assessment of the operating condition of every trap at least annually:
  - trap operation,
  - trap selection,
  - trap installation, and
  - condensate return.
4. Develop and maintain a trap database.
5. Respond to assessment findings.

All of these activities are critical to successfully managing a steam trap population. Clearly identified areas of responsibility and an overall manager are key ingredients. The steam trap database should become the primary tool for tracking trap performance. The steam trap database should contain trap manufacturer, type, and model as well as location and history. Computerized databases are excellent for this application; many companies have software developed to accomplish this task.

### 6.3 INSULATION

Insulating piping, equipment, and vessels is a fundamental principal of energy management. A determination of the amount of energy lost from uninsulated equipment will provide the basis for determining the extent of an insulation project. The main factors that affect the amount of energy lost from uninsulated or poorly insulated equipment are process fluid temperature, ambient temperature, surface area exposed to heat transfer, and the system's resistance to heat transfer. This last factor is the most difficult to establish because it is determined by factors such as ambient air velocity, equipment orientation, and the shape of the heat transfer surface. However tables have been developed for typical systems such as horizontal and vertical pipes. These tables allow heat loss estimates to be established with relative ease. Table 7 is an example of a heat loss table. For example, 100 ft of 8-in. uninsulated pipe carrying 600°F steam would result in a heat transfer loss of approximately 723,700 Btu/h. This energy is supplied in the boiler with an efficiency of 85% and a fuel cost of \$7.15/10<sup>6</sup> Btu. The loss associated with the uninsulated pipe is calculated below.

$$\lambda_{\text{uninsulated}} = \frac{\dot{Q}_{\text{loss}} T_{\kappa} \kappa_{\text{fuel}}}{\eta_{\text{boiler}}} = 723,700 \text{ Btu/h} (8,760 \text{ h/year}) \$7.15/10^6 \text{ Btu} \left( \frac{1}{0.85} \right) \quad (57)$$

$$\lambda_{\text{uninsulated}} = \$53,000/\text{year} \quad .$$

In general, insulation is relatively inexpensive to install. All of the energy loss indicated above cannot economically be eliminated. Therefore, an analysis must be completed to determine the economic insulation thickness. Many empirical and computerized tools are available to aid in the evaluation of insulation projects. One excellent tool is the 3E-Plus insulation appraisal software.<sup>11</sup>

**Table 7. Pipe surface heat transfer**

Nominal pipe diameter (in.)	Heat transfer from uninsulated pipe exposed to 10-mile/h wind and 70°F ambient [Btu/(h linear ft)]					
	Process fluid temperature (°F)					
	200	400	600	800	1,000	1,200
1/2	274	731	1,279	1,963	2,865	4,030
1	354	959	1,712	2,694	3,995	5,708
2	514	1,416	2,591	4,167	6,324	9,247
3	708	1,849	3,425	5,605	8,619	12,728
4	845	2,352	4,132	6,838	10,605	15,776
5	982	2,751	5,126	8,105	12,671	18,938
6	1,107	3,128	5,868	9,726	14,692	22,055
8	1,336	3,824	7,237	12,089	18,973	27,785
10	1,575	4,532	8,642	14,543	22,945	34,498
12	1,792	5,183	9,932	16,826	26,678	40,274
16	2,135	6,210	12,009	20,491	32,705	49,623
20	2,534	7,443	14,509	24,932	40,034	61,039
24	2,934	8,699	17,078	29,315	47,283	72,352

#### 6.4 CONDENSATE RECOVERY

The steam trap management program should investigate every steam trap and determine if condensate is captured or lost from the system. This was pointed out in Sect. 6.2.2 of this text. This section serves to highlight the primary aspects associated with condensate recovery.

The primary points of focus when considering collection of condensate and return to the steam system are

- the energy resident in the condensate,
- water commodity costs,
- water treatment aspects, and
- wastewater charges.

Generally, the energy resident in the condensate constitutes the majority of the economic impact associated with returning condensate. However, in many locations, the purchase of water and the subsequent wastewater charges associated with the sewer system are significant factors. In most applications, water treatment costs are difficult to establish; however, effort should be made to establish and incorporate these costs to obtain a true representation of condensate worth.

For the most part, condensate supplied from steam turbine condensers is the best quality water at the plant site. The water exiting the condenser is distilled water, and generally it has had little opportunity for contamination. However, steam turbine condenser condensate has a relatively low temperature and, as a result, a minimal worth. This water is easily captured; therefore, it becomes a mainstay of boiler feedwater.

Condensate returned from process heat exchangers typically has an elevated temperature and, therefore, a significant energy value. Energy savings result from the elevated temperature of the returned condensate in comparison with makeup water required to replace the condensate if it is lost from the system.

As an example, the savings associated with recovering 5,000 lb<sub>m</sub>/h of 180°F condensate will be calculated. This condensate flow is approximately 10 gal/min. The system fuel cost is \$7.15/10<sup>6</sup> Btu, and the boiler efficiency is 85%. Makeup water enters the system at 70°F.

$$\text{Condensate return savings} = \sigma_{\text{condensate}} = \frac{\dot{m}_{\text{condensate}}(h_{\text{condensate}} - h_{\text{makeup}})T \kappa_{\text{fuel}}}{\eta_{\text{boiler}}}$$

$$\sigma_{\text{condensate}} = 5,000 \text{ lb}_m/\text{h} (147.91 - 38.05 \text{ Btu}/\text{lb}_m) (8,760 \text{ h}/\text{year}) \$7.15/10^6 \text{ Btu} \left( \frac{1}{0.85} \right) \quad (58)$$

$$\sigma_{\text{condensate}} = \$40,000/\text{year} .$$

Condensate collection systems usually consist of collection piping receiving the output of several traps. The collection piping discharges into a receiver equipped with a pump and pipe system to transport the condensate to the feedwater treatment system. A common problem associated with this type of system is insufficient condensate pipe capacity. Most often the capacity problem is a result of the original design, not considering the flow of flash steam in the condensate and the effect of failed traps on the steam flow through the piping. These factors greatly influence the required size of the condensate pipe and must be considered in the system design.

Condensate is often not recovered because of fear of contamination. If a heat exchanger develops a leak, then process fluids can enter the steam and condensate system. This is a legitimate concern. Many systems successfully employ monitoring systems that can detect contamination and reroute the condensate to a sewer system if contamination is detected. Conductivity and pH are two very common, fairly rugged, and repeatable measurements used in this service. Total organic carbon analyzers are also used in this service.

## 6.5 FLASH STEAM RECOVERY

In many applications condensate enters a steam trap as a saturated liquid. The condensate enters the trap as a relatively high-pressure saturated liquid and exits to a lower pressure system. A thermodynamic analysis of the flow through the steam trap simplifies the process to a classic throttling device.<sup>8</sup> Thermodynamically, a throttling device passes a fluid from high to low pressure with no change in enthalpy,  $h$ . The process is said to be *isenthalpic*. The enthalpy of the high-pressure saturated liquid is greater than the enthalpy of saturated liquid at the reduced pressure; therefore, the low-pressure fluid exiting the trap cannot exist as liquid condensate alone. As a result, some of the liquid condensate “flashes” to steam. The remainder of the liquid condensate exists as saturated liquid condensate at the reduced pressure. The low-pressure flash steam exists as saturated vapor at the reduced pressure. This steam is available for use in low-pressure steam systems. The amount of flash steam can be calculated by the following equation.

$$X = \frac{h_{\text{HP cond}} - h_{\text{LP sat liq}}}{h_{\text{LP sat vap}} - h_{\text{LP sat liq}}} , \quad (59)$$

where  $X$  is the mass fraction of flash steam, and the  $h$  values are the corresponding enthalpies.

A common and effective method used for flash steam recovery is to incorporate a flash vessel into the condensate collection system. The system is identical to the blowdown flash steam recovery system described in Sect. 4.2.4. A simplified schematic is provided in Fig. 8.

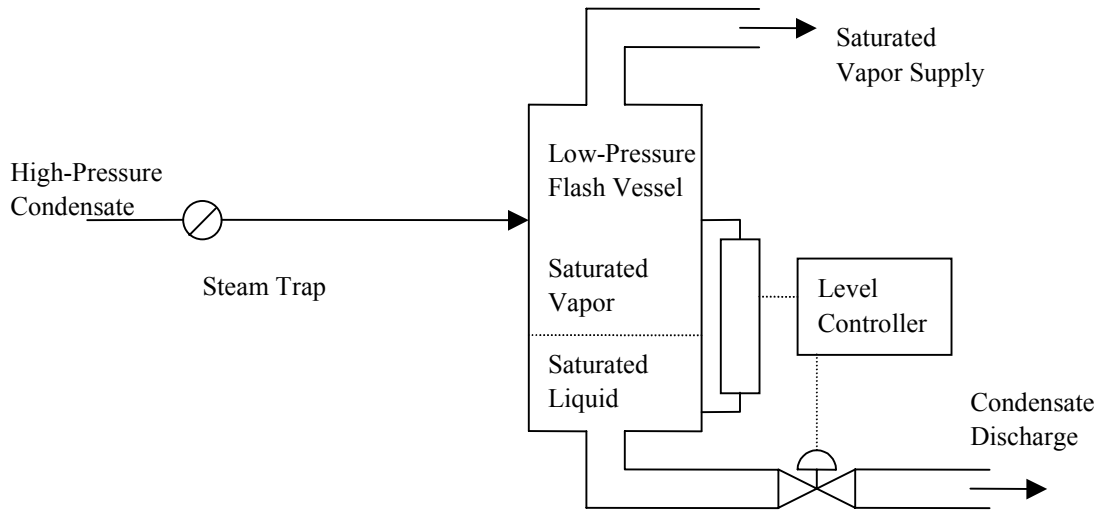

**Fig. 8. Flash steam recovery vessel.**

Flash steam recovery not only reduces economic losses from the system, but it also reduces the steam flow in condensate return systems. The condensate flow out of the flash tank will have much less flash steam. If the discharge is pumped and the pressure is maintained greater than the flash vessel pressure, no flash steam will result in the condensate discharge piping.

To manage this type of system, a flowmeter should be installed in the flash steam exit. This steam flow should be monitored and recorded with respect to appropriate variables. The primary concern is to identify failed steam traps blowing through. The steam will be passed through to the flash steam outlet.

## 6.6 CALL TO ACTION—DISTRIBUTION SYSTEM LOSSES

1. Find and repair steam leaks.
2. Implement a steam trap management program.
3. Investigate potential areas for condensate return.
4. Evaluate insulation condition.
5. Investigate opportunities to reintroduce flash steam.



## REFERENCES

1. J. Keenan, F. Keyes, P. Hill, and J. Moore, *Steam Tables, Thermodynamic Properties of Water Including Vapor, Liquid, and Solid Phases*, John Wiley and Sons, 1969.
2. J. Hartley, G. Woodruff, and W. Black, *Thermodynamic Properties, Version 2.0 (software) to Accompany Thermodynamics, Second Edition*, Harper Collins Publishers, 1990.
3. *NIST/ASME Steam Properties Database: Version 2.2* (software), National Institute for Standards and Testing.
4. *Steam Its Generation and Use*, The Babcock and Wilcox Company, 1978.
5. E. Avallone and T. Baumeister, *Mark's Standard Handbook for Mechanical Engineers*, McGraw-Hill Book Company, 1999.
6. F. Kemmer, *The Nalco Water Handbook*, 2nd Edition, McGraw Hill, 1988.
7. G. Fryling, *Combustion Engineering*, Combustion Engineering, 1966.
8. M. J. Moran and H. N. Shapiro, *Fundamentals of Engineering Thermodynamics*, 2nd Edition, John Wiley and Sons, 1992.
9. *Steam Its Generation and Use*, 40th Edition, The Babcock and Wilcox Company, 1992.
10. *Motor Master Plus, Software*, U.S. Department of Energy Office of Industrial Technology, Motor Challenge Program, 2001.
11. *North American Insulation Manufacturers Association 3E Plus* (software), NAIMA.

## SELECTED BIBLIOGRAPHY

- ASME PTC 4.1, Steam Generating Units*, The American Society of Mechanical Engineers.
- Betz Handbook of Industrial Water Conditioning*, 1980. Betz Laboratories.
- Getting the Most Out of Your Medium Steam Turbine-Generator*, 1979. General Electric Company.
- Incropera, F., and Dewitt, D. 1985. *Fundamentals of Heat and Mass Transfer*, 2nd Edition, John Wiley and Sons.
- Li, K. W., and Priddy, A. P. 1985. *Power Plant System Design*, John Wiley and Sons.
- Newman, Keller, Lyons, and Wales. 1944. *Modern Turbines*, General Electric.
- Perry, R. H., Green, D. W., and Maloney, J. O. 1984. *Perry's Chemical Engineers' Handbook*, 6th Edition, McGraw-Hill Book Company.
- Van Wylen, G. J., and Sonntag, R. E. 1973. *Fundamentals of Classical Thermodynamics*, John Wiley and Sons.
- Weber, W. 1972. *Physicochemical Processes for Water Quality Control*, John Wiley and Sons.
- White, F. M. 1979. *Fluid Mechanics*, McGraw-Hill Book Company.
- Woodruff, Lammers, and Lammers. 1984. *Steam Plant Operation*, 5th Edition, McGraw-Hill Book Company.

**Appendix A**  
**STEAM PROPERTIES**



Tables A.1–A.6 were developed based on data in “Steam Program Function Subroutines Written in Fortran,” *Mechanical Engineering News*, 19(3), 11–12 (August 1982).

**Table A.1. Saturated vapor properties—pressure**

Temperature (°F)	Pressure (psia)	Specific volume (ft <sup>3</sup> /lb <sub>m</sub> )	Internal energy (Btu/lb <sub>m</sub> )	Enthalpy (Btu/lb <sub>m</sub> )	Entropy (Btu/lb <sub>m</sub> °R)	Quality (%)
102	1.0	333.54579	1,044.22	1,105.94	1.98473	100.0
162	5.0	73.52409	1,063.07	1,131.09	1.84342	100.0
193	10.0	38.41991	1,072.20	1,143.29	1.78571	100.0
212	14.7	26.79334	1,077.53	1,150.41	1.75442	100.0
228	20.0	20.08862	1,081.90	1,156.25	1.72980	100.0
240	25.0	16.30338	1,085.13	1,160.55	1.71218	100.0
250	30.0	13.74552	1,087.79	1,164.10	1.69791	100.0
259	35.0	11.89768	1,090.06	1,167.11	1.68594	100.0
267	40.0	10.49823	1,092.02	1,169.73	1.67564	100.0
274	45.0	9.40041	1,093.76	1,172.04	1.66661	100.0
281	50.0	8.51542	1,095.31	1,174.10	1.65857	100.0
293	60.0	7.17489	1,097.98	1,177.64	1.64475	100.0
303	70.0	6.20609	1,100.22	1,180.61	1.63316	100.0
312	80.0	5.47216	1,102.12	1,183.13	1.62318	100.0
320	90.0	4.89626	1,103.78	1,185.32	1.61443	100.0
328	100.0	4.43190	1,105.23	1,187.24	1.60665	100.0
341	120.0	3.72834	1,107.66	1,190.45	1.60242	100.0
353	140.0	3.21974	1,109.61	1,193.02	1.58520	100.0
364	160.0	2.83434	1,111.21	1,195.13	1.57044	100.0
373	180.0	2.53188	1,112.55	1,196.88	1.55753	100.0
382	200.0	2.28796	1,113.66	1,198.34	1.54607	100.0
390	220.0	2.08695	1,114.60	1,199.56	1.53578	100.0
397	240.0	1.91833	1,115.40	1,200.59	1.52645	100.0
404	260.0	1.77480	1,116.07	1,201.46	1.51791	100.0
411	280.0	1.65108	1,116.64	1,202.19	1.51005	100.0
417	300.0	1.54330	1,117.12	1,202.80	1.50277	100.0
423	320.0	1.44854	1,117.53	1,203.31	1.49599	100.0
429	340.0	1.36455	1,117.87	1,203.72	1.48965	100.0
434	360.0	1.28957	1,118.14	1,204.05	1.48369	100.0
440	380.0	1.22221	1,118.37	1,204.31	1.47808	100.0
445	400.0	1.16136	1,118.55	1,204.51	1.47278	100.0
449	420.0	1.10610	1,118.69	1,204.65	1.46775	100.0
454	440.0	1.05569	1,118.78	1,204.74	1.46298	100.0
459	460.0	1.00951	1,118.85	1,204.78	1.45843	100.0
463	480.0	0.96705	1,118.88	1,204.78	1.45408	100.0
467	500.0	0.92787	1,118.89	1,204.74	1.44993	100.0
471	520.0	0.89159	1,118.87	1,204.66	1.44595	100.0
475	540.0	0.85791	1,118.83	1,204.55	1.44213	100.0
479	560.0	0.82655	1,118.76	1,204.42	1.43846	100.0
483	580.0	0.79727	1,118.68	1,204.25	1.43493	100.0
486	600.0	0.76988	1,118.58	1,204.06	1.43153	100.0

**Table A.1. (continued)**

<b>Temperature (°F)</b>	<b>Pressure (psia)</b>	<b>Specific volume (ft<sup>3</sup>/lb<sub>m</sub>)</b>	<b>Internal energy (Btu/lb<sub>m</sub>)</b>	<b>Enthalpy (Btu/lb<sub>m</sub>)</b>	<b>Entropy (Btu/lb<sub>m</sub>°R)</b>	<b>Quality (%)</b>
490	620.0	0.74419	1,118.46	1,203.84	1.42824	100.0
493	640.0	0.72006	1,118.32	1,203.60	1.42507	100.0
497	660.0	0.69733	1,118.18	1,203.34	1.42200	100.0
500	680.0	0.67590	1,118.02	1,203.07	1.41903	100.0
503	700.0	0.65564	1,117.84	1,202.77	1.41615	100.0
506	720.0	0.63648	1,117.66	1,202.46	1.41335	100.0
509	740.0	0.61831	1,117.46	1,202.13	1.41064	100.0
512	760.0	0.60106	1,117.26	1,201.79	1.40801	100.0
515	780.0	0.58467	1,117.04	1,201.43	1.40545	100.0
518	800.0	0.56907	1,116.82	1,201.06	1.40296	100.0
521	820.0	0.55421	1,116.59	1,200.68	1.40053	100.0
524	840.0	0.54003	1,116.35	1,200.29	1.39817	100.0
527	860.0	0.52648	1,116.10	1,199.89	1.39587	100.0
529	880.0	0.51353	1,115.85	1,199.47	1.39362	100.0
532	900.0	0.50113	1,115.59	1,199.05	1.39143	100.0
535	920.0	0.48926	1,115.32	1,198.62	1.38929	100.0
537	940.0	0.47787	1,115.05	1,198.18	1.38719	100.0
540	960.0	0.46694	1,114.78	1,197.73	1.38515	100.0
542	980.0	0.45645	1,114.50	1,197.27	1.38315	100.0
545	1,000.0	0.44635	1,114.21	1,196.81	1.38119	100.0

**Table A.2. Saturated vapor properties—temperature**

<b>Temperature (°F)</b>	<b>Pressure (psia)</b>	<b>Specific volume (ft<sup>3</sup>/lb<sub>m</sub>)</b>	<b>Internal energy (Btu/lb<sub>m</sub>)</b>	<b>Enthalpy (Btu/lb<sub>m</sub>)</b>	<b>Entropy (Btu/lb<sub>m</sub>°R)</b>	<b>Quality (%)</b>
100	0.9	350.34470	1,043.66	1,105.20	1.98949	100.0
120	1.7	203.26536	1,050.01	1,113.67	1.93738	100.0
140	2.9	123.00672	1,056.26	1,122.01	1.89043	100.0
160	4.7	77.29142	1,062.39	1,130.19	1.84794	100.0
180	7.5	50.22845	1,068.35	1,138.16	1.80933	100.0
200	11.5	33.64085	1,074.14	1,145.89	1.77411	100.0
212	14.7	26.80026	1,077.52	1,150.40	1.75444	100.0
220	17.2	23.14935	1,079.74	1,153.36	1.74188	100.0
240	25.0	16.32189	1,085.11	1,160.53	1.71227	100.0
260	35.4	11.76240	1,090.24	1,167.35	1.68500	100.0
280	49.2	8.64488	1,095.08	1,173.79	1.65980	100.0
300	67.0	6.46697	1,099.58	1,179.77	1.63644	100.0
320	89.6	4.91524	1,103.72	1,185.25	1.61473	100.0
340	118.0	3.78954	1,107.43	1,190.15	1.60433	100.0
360	153.0	2.95925	1,110.68	1,194.44	1.57540	100.0
380	195.6	2.33743	1,113.42	1,198.04	1.54847	100.0
400	247.1	1.86514	1,115.64	1,200.92	1.52334	100.0
420	308.5	1.50170	1,117.29	1,203.03	1.49982	100.0
440	381.2	1.21864	1,118.37	1,204.33	1.47776	100.0
460	466.4	0.99568	1,118.85	1,204.79	1.45701	100.0
480	565.7	0.81821	1,118.72	1,204.37	1.43745	100.0
500	680.4	0.67558	1,118.00	1,203.06	1.41897	100.0
520	812.3	0.55991	1,116.67	1,200.83	1.40146	100.0
540	963.0	0.46531	1,114.75	1,197.66	1.38485	100.0
560	1,134.3	0.38734	1,112.24	1,193.54	1.36905	100.0
580	1,328.3	0.32262	1,109.14	1,188.44	1.35399	100.0
600	1,547.0	0.26856	1,105.48	1,182.36	1.33960	100.0
620	1,792.7	0.22316	1,101.25	1,175.28	1.32584	100.0
640	2,067.8	0.18485	1,096.45	1,167.18	1.27863	100.0
660	2,374.9	0.15241	1,091.07	1,158.05	1.24458	100.0
680	2,716.9	0.12487	1,085.09	1,147.87	1.21237	100.0
700	3,096.8	0.10147	1,078.47	1,136.62	1.18183	100.0

**Table A.3. Saturated liquid properties—pressure**

<b>Temperature (°F)</b>	<b>Pressure (psia)</b>	<b>Specific volume (ft<sup>3</sup>/lb<sub>m</sub>)</b>	<b>Internal energy (Btu/lb<sub>m</sub>)</b>	<b>Enthalpy (Btu/lb<sub>m</sub>)</b>	<b>Entropy (Btu/lb<sub>m</sub>°R)</b>	<b>Quality (%)</b>
102	1.0	0.01613	69.71	69.71	0.13261	0.0
162	5.0	0.01640	130.10	130.12	0.23468	0.0
193	10.0	0.01659	161.14	161.17	0.28341	0.0
212	14.7	0.01671	180.05	180.09	0.31198	0.0
228	20.0	0.01683	196.11	196.18	0.33565	0.0
240	25.0	0.01692	208.35	208.43	0.35330	0.0
250	30.0	0.01700	218.74	218.83	0.36805	0.0
259	35.0	0.01708	227.81	227.92	0.38077	0.0
267	40.0	0.01715	235.90	236.03	0.39196	0.0
274	45.0	0.01721	243.23	243.37	0.40199	0.0
281	50.0	0.01727	249.93	250.09	0.41107	0.0
293	60.0	0.01738	261.89	262.08	0.42708	0.0
303	70.0	0.01748	272.37	272.60	0.44091	0.0
312	80.0	0.01757	281.74	282.00	0.45312	0.0
320	90.0	0.01766	290.25	290.54	0.46407	0.0
328	100.0	0.01774	298.06	298.38	0.47401	0.0
341	120.0	0.01789	312.03	312.43	0.49158	0.0
353	140.0	0.01803	324.33	324.80	0.50680	0.0
364	160.0	0.01815	335.37	335.91	0.52027	0.0
373	180.0	0.01827	345.42	346.03	0.53239	0.0
382	200.0	0.01838	354.67	355.35	0.54343	0.0
390	220.0	0.01849	363.27	364.02	0.55358	0.0
397	240.0	0.01860	371.30	372.13	0.56299	0.0
404	260.0	0.01870	378.87	379.77	0.57177	0.0
411	280.0	0.01879	386.02	386.99	0.58001	0.0
417	300.0	0.01889	392.81	393.86	0.58778	0.0
423	320.0	0.01898	399.29	400.41	0.59514	0.0
429	340.0	0.01907	405.48	406.68	0.60213	0.0
434	360.0	0.01916	411.42	412.69	0.60880	0.0
440	380.0	0.01924	417.13	418.48	0.61517	0.0
445	400.0	0.01933	422.63	424.06	0.62128	0.0
449	420.0	0.01941	427.94	429.45	0.62714	0.0
454	440.0	0.01949	433.08	434.67	0.63279	0.0
459	460.0	0.01958	438.07	439.73	0.63823	0.0
463	480.0	0.01966	442.90	444.65	0.64349	0.0
467	500.0	0.01974	447.60	449.42	0.64858	0.0
471	520.0	0.01982	452.17	454.08	0.65351	0.0
475	540.0	0.01989	456.62	458.61	0.65830	0.0
479	560.0	0.01997	460.97	463.04	0.66294	0.0
483	580.0	0.02005	465.21	467.36	0.66746	0.0
486	600.0	0.02013	469.36	471.59	0.67186	0.0



Table A.3. (continued)

Temperature (°F)	Pressure (psia)	Specific volume (ft <sup>3</sup> /lb <sub>m</sub> )	Internal energy (Btu/lb <sub>m</sub> )	Enthalpy (Btu/lb <sub>m</sub> )	Entropy (Btu/lb <sub>m</sub> °R)	Quality (%)
490	620.0	0.02020	473.41	475.73	0.67615	0.0
493	640.0	0.02028	477.38	479.78	0.68033	0.0
497	660.0	0.02035	481.27	483.76	0.68441	0.0
500	680.0	0.02043	485.09	487.66	0.68840	0.0
503	700.0	0.02050	488.83	491.49	0.69230	0.0
506	720.0	0.02058	492.51	495.25	0.69612	0.0
509	740.0	0.02065	496.12	498.94	0.69986	0.0
512	760.0	0.02073	499.66	502.58	0.70352	0.0
515	780.0	0.02080	503.16	506.16	0.70711	0.0
518	800.0	0.02087	506.59	509.68	0.71064	0.0
521	820.0	0.02095	509.97	513.15	0.71410	0.0
524	840.0	0.02102	513.31	516.57	0.71750	0.0
527	860.0	0.02109	516.59	519.95	0.72084	0.0
529	880.0	0.02117	519.83	523.28	0.72412	0.0
532	900.0	0.02124	523.03	526.56	0.72736	0.0
535	920.0	0.02131	526.18	529.81	0.73054	0.0
537	940.0	0.02139	529.29	533.01	0.73367	0.0
540	960.0	0.02146	532.37	536.18	0.73676	0.0
542	980.0	0.02153	535.41	539.31	0.73980	0.0
545	1,000.0	0.02161	538.41	542.41	0.74280	0.0

**Table A.4. Saturated liquid properties—temperature**

<b>Temperature (°F)</b>	<b>Pressure (psia)</b>	<b>Specific volume (ft<sup>3</sup>/lb<sub>m</sub>)</b>	<b>Internal energy (Btu/lb<sub>m</sub>)</b>	<b>Enthalpy (Btu/lb<sub>m</sub>)</b>	<b>Entropy (Btu/lb<sub>m</sub>°R)</b>	<b>Quality (%)</b>
100	0.9	0.01613	67.97	67.97	0.12951	0.0
120	1.7	0.01620	87.91	87.92	0.16448	0.0
140	2.9	0.01629	107.87	107.88	0.19830	0.0
160	4.7	0.01639	127.86	127.88	0.23107	0.0
180	7.5	0.01650	147.89	147.91	0.26289	0.0
200	11.5	0.01663	167.96	168.00	0.29381	0.0
212	14.7	0.01671	180.03	180.07	0.31196	0.0
220	17.2	0.01677	188.09	188.14	0.32390	0.0
240	25.0	0.01692	208.27	208.35	0.35320	0.0
260	35.4	0.01708	228.54	228.65	0.38178	0.0
280	49.2	0.01726	248.90	249.06	0.40969	0.0
300	67.0	0.01745	269.37	269.59	0.43698	0.0
320	89.6	0.01766	289.98	290.27	0.46371	0.0
340	118.0	0.01788	310.73	311.12	0.48995	0.0
360	153.0	0.01811	331.65	332.17	0.51576	0.0
380	195.6	0.01836	352.78	353.44	0.54117	0.0
400	247.1	0.01863	374.12	374.97	0.56626	0.0
420	308.5	0.01893	395.70	396.78	0.59107	0.0
440	381.2	0.01925	417.56	418.92	0.61565	0.0
460	466.4	0.01960	439.74	441.43	0.64006	0.0
480	565.7	0.02000	462.28	464.37	0.66434	0.0
500	680.4	0.02043	485.24	487.81	0.68856	0.0
520	812.3	0.02092	508.70	511.84	0.71280	0.0
540	963.0	0.02147	532.77	536.59	0.73716	0.0
560	1,134.3	0.02209	557.58	562.22	0.76179	0.0
580	1,328.3	0.02280	583.32	588.93	0.78689	0.0
600	1,547.0	0.02361	610.22	616.98	0.81273	0.0
620	1,792.7	0.02452	638.58	646.72	0.83968	0.0
640	2,067.8	0.02557	668.79	678.57	0.86822	0.0
660	2,374.9	0.02677	701.30	713.06	0.89899	0.0
680	2,716.9	0.02813	736.71	750.85	0.93282	0.0
700	3,096.8	0.02969	775.74	792.75	0.97074	0.0

**Table A.5. Superheated steam properties**

<b>Temperature (°F)</b>	<b>Pressure (psia)</b>	<b>Specific volume (ft<sup>3</sup>/lb<sub>m</sub>)</b>	<b>Internal energy (Btu/lb<sub>m</sub>)</b>	<b>Enthalpy (Btu/lb<sub>m</sub>)</b>	<b>Entropy (Btu/lb<sub>m</sub>°R)</b>	<b>Quality (%)</b>
228	20.0	20.08862	1,081.90	1,156.25	1.72980	100.0
250	20.0	20.79400	1,090.31	1,167.27	1.74760	****
275	20.0	21.58306	1,099.65	1,179.53	1.76459	****
300	20.0	22.36341	1,108.85	1,191.62	1.78077	****
325	20.0	23.13727	1,117.97	1,203.60	1.79628	****
350	20.0	23.90620	1,127.03	1,215.51	1.81122	****
375	20.0	24.67129	1,136.06	1,227.37	1.82565	****
281	50.0	8.51542	1,095.31	1,174.10	1.65857	100.0
300	50.0	8.77247	1,103.11	1,184.28	1.67209	****
325	50.0	9.10358	1,113.12	1,197.35	1.68903	****
350	50.0	9.42849	1,122.88	1,210.12	1.70504	****
375	50.0	9.74874	1,132.46	1,222.66	1.72030	****
400	50.0	10.06539	1,141.92	1,235.05	1.73493	****
425	50.0	10.37923	1,151.31	1,247.34	1.74902	****
328	100.0	4.43190	1,105.23	1,187.24	1.60665	100.0
350	100.0	4.59216	1,115.12	1,200.09	1.61882	****
375	100.0	4.76689	1,125.85	1,214.06	1.63581	****
400	100.0	4.93702	1,136.21	1,227.57	1.65176	****
425	100.0	5.10365	1,146.31	1,240.75	1.66688	****
450	100.0	5.26758	1,156.22	1,253.70	1.68131	****
475	100.0	5.42936	1,166.01	1,266.48	1.69517	****
358	150.0	3.01465	1,110.45	1,194.13	1.57756	100.0
375	150.0	3.09940	1,118.41	1,204.45	1.58194	****
400	150.0	3.22251	1,129.90	1,219.35	1.59953	****
425	150.0	3.34135	1,140.87	1,233.62	1.61589	****
450	150.0	3.45696	1,151.47	1,247.43	1.63129	****
475	150.0	3.57007	1,161.81	1,260.91	1.64591	****
500	150.0	3.68122	1,171.96	1,274.14	1.65988	****
382	200.0	2.28796	1,113.66	1,198.34	1.54607	100.0
400	200.0	2.36110	1,122.94	1,210.33	1.55943	****
425	200.0	2.45715	1,134.96	1,225.90	1.57729	****
450	200.0	2.54937	1,146.37	1,240.73	1.59382	****
475	200.0	2.63870	1,157.35	1,255.01	1.60931	****
500	200.0	2.72578	1,168.01	1,268.90	1.62397	****
525	200.0	2.81109	1,178.44	1,282.48	1.63795	****
401	250.0	1.84380	1,115.75	1,201.05	1.52209	100.0
425	250.0	1.92394	1,128.54	1,217.54	1.54514	****
450	250.0	2.00285	1,140.90	1,233.56	1.56299	****
475	250.0	2.07839	1,152.62	1,248.77	1.57949	****
500	250.0	2.15139	1,163.86	1,263.39	1.59493	****
525	250.0	2.22241	1,174.76	1,277.58	1.60952	****
550	250.0	2.29185	1,185.40	1,291.43	1.62342	****

Table A. 5. (continued)

Temperature (°F)	Pressure (psia)	Specific volume (ft <sup>3</sup> /lb <sub>m</sub> )	Internal energy (Btu/lb <sub>m</sub> )	Enthalpy (Btu/lb <sub>m</sub> )	Entropy (Btu/lb <sub>m</sub> °R)	Quality (%)
417	300.0	1.54330	1,117.12	1,202.80	1.50277	100.0
425	300.0	1.56597	1,121.54	1,208.48	1.51676	****
450	300.0	1.63670	1,135.02	1,225.88	1.53616	****
475	300.0	1.70353	1,147.58	1,242.15	1.55381	****
500	300.0	1.76747	1,159.49	1,257.61	1.57013	****
525	300.0	1.82919	1,170.91	1,272.46	1.58541	****
550	300.0	1.88918	1,181.98	1,286.86	1.59985	****
432	350.0	1.32603	1,118.01	1,203.90	1.48662	100.0
450	350.0	1.37346	1,128.69	1,217.65	1.51187	****
475	350.0	1.43454	1,142.23	1,235.14	1.53084	****
500	350.0	1.49233	1,154.87	1,251.53	1.54815	****
525	350.0	1.54763	1,166.88	1,267.12	1.56419	****
550	350.0	1.60102	1,178.42	1,282.11	1.57922	****
575	350.0	1.65291	1,189.60	1,296.65	1.59345	****
445	400.0	1.16136	1,118.55	1,204.51	1.47278	100.0
450	400.0	1.17436	1,121.86	1,208.79	1.48922	****
475	400.0	1.23161	1,136.52	1,227.68	1.50971	****
500	400.0	1.28511	1,150.01	1,245.13	1.52814	****
525	400.0	1.33582	1,162.66	1,261.54	1.54502	****
550	400.0	1.38442	1,174.71	1,277.19	1.56071	****
575	400.0	1.43137	1,186.30	1,292.25	1.57545	****
456	450.0	1.03211	1,118.82	1,204.77	1.46067	100.0
475	450.0	1.07262	1,130.42	1,219.74	1.48984	****
500	450.0	1.12311	1,144.86	1,238.38	1.50953	****
525	450.0	1.17047	1,158.24	1,255.71	1.52735	****
550	450.0	1.21549	1,170.85	1,272.07	1.54376	****
575	450.0	1.25872	1,182.90	1,287.71	1.55907	****
600	450.0	1.30054	1,194.51	1,302.81	1.57349	****
467	500.0	0.92787	1,118.89	1,204.74	1.44993	100.0
475	500.0	0.94428	1,123.90	1,211.27	1.47081	****
500	500.0	0.99269	1,139.41	1,231.26	1.49193	****
525	500.0	1.03760	1,153.60	1,249.60	1.51080	****
550	500.0	1.07991	1,166.83	1,266.75	1.52800	****
575	500.0	1.12027	1,179.37	1,283.02	1.54392	****
600	500.0	1.15910	1,191.38	1,298.62	1.55882	****
477	550.0	0.84195	1,118.80	1,204.49	1.44028	100.0
500	550.0	0.88517	1,133.64	1,223.73	1.47505	****
525	550.0	0.92830	1,148.73	1,243.21	1.49509	****
550	550.0	0.96856	1,162.64	1,261.22	1.51315	****
575	550.0	1.00667	1,175.71	1,278.17	1.52973	****
600	550.0	1.04313	1,188.14	1,294.31	1.54515	****
625	550.0	1.07830	1,200.10	1,309.85	1.55965	****

Table A.5. (continued)

Temperature (°F)	Pressure (psia)	Specific volume (ft <sup>3</sup> /lb <sub>m</sub> )	Internal energy (Btu/lb <sub>m</sub> )	Enthalpy (Btu/lb <sub>m</sub> )	Entropy (Btu/lb <sub>m</sub> °R)	Quality (%)
486	600.0	0.76988	1,118.58	1,204.06	1.43153	100.0
500	600.0	0.79477	1,127.51	1,215.75	1.45865	****
550	600.0	0.87535	1,158.27	1,255.46	1.49901	****
600	600.0	0.94626	1,184.81	1,289.87	1.53229	****
650	600.0	1.01152	1,209.03	1,321.34	1.56131	****
700	600.0	1.07317	1,231.90	1,351.06	1.58752	****
750	600.0	1.13239	1,253.97	1,379.70	1.61170	****
495	650.0	0.70853	1,118.25	1,203.48	1.42352	100.0
500	650.0	0.71746	1,120.99	1,207.29	1.44255	****
550	650.0	0.79607	1,153.70	1,249.45	1.48542	****
600	650.0	0.86407	1,181.36	1,285.30	1.52008	****
650	650.0	0.92599	1,206.30	1,317.68	1.54995	****
700	650.0	0.98411	1,229.65	1,348.03	1.57670	****
750	650.0	1.03967	1,252.07	1,377.12	1.60127	****
503	700.0	0.65564	1,117.84	1,202.77	1.41615	100.0
525	700.0	0.69098	1,132.50	1,222.01	1.45100	****
575	700.0	0.76160	1,163.89	1,262.54	1.49118	****
625	700.0	0.82360	1,190.95	1,297.63	1.52431	****
675	700.0	0.88052	1,215.60	1,329.66	1.55319	****
725	700.0	0.93419	1,238.86	1,359.87	1.57924	****
775	700.0	0.98564	1,261.26	1,388.93	1.60327	****
511	750.0	0.60958	1,117.36	1,201.96	1.40932	100.0
525	750.0	0.63187	1,126.49	1,214.19	1.43684	****
575	750.0	0.70113	1,159.64	1,256.94	1.47923	****
625	750.0	0.76103	1,187.72	1,293.34	1.51360	****
675	750.0	0.81551	1,213.03	1,326.21	1.54324	****
725	750.0	0.86656	1,236.73	1,357.00	1.56979	****
775	750.0	0.91532	1,259.45	1,386.48	1.59417	****
518	800.0	0.56907	1,116.82	1,201.06	1.40296	100.0
525	800.0	0.57955	1,120.14	1,205.93	1.42277	****
575	800.0	0.64792	1,155.21	1,251.13	1.46759	****
625	800.0	0.70612	1,184.40	1,288.93	1.50329	****
675	800.0	0.75853	1,210.40	1,322.69	1.53373	****
725	800.0	0.80733	1,234.57	1,354.08	1.56080	****
775	800.0	0.85375	1,257.62	1,384.01	1.58555	****
525	850.0	0.53318	1,116.22	1,200.09	1.39701	100.0
550	850.0	0.56859	1,133.17	1,222.61	1.43417	****
600	850.0	0.63009	1,166.39	1,265.50	1.47566	****
650	850.0	0.68342	1,194.68	1,302.18	1.50950	****
700	850.0	0.73196	1,220.24	1,335.37	1.53877	****
750	850.0	0.77746	1,244.19	1,366.47	1.56503	****
800	850.0	0.82088	1,267.15	1,396.27	1.58917	****

**Table A.6. Subcooled liquid properties**

<b>Temperature (°F)</b>	<b>Pressure (psia)</b>	<b>Specific volume (ft<sup>3</sup>/lb<sub>m</sub>)</b>	<b>Internal energy (Btu/lb<sub>m</sub>)</b>	<b>Enthalpy (Btu/lb<sub>m</sub>)</b>	<b>Entropy (Btu/lb<sub>m</sub>°R)</b>	<b>Quality (%)</b>
212	14.7	0.01671	180.05	180.09	0.31198	0.0
200	14.7	0.01663	167.95	168.00	0.29381	****
150	14.7	0.01634	117.83	117.88	0.21481	****
100	14.7	0.01613	67.93	67.97	0.12951	****
50	14.7	0.01598	18.02	18.06	0.03601	****
281	50.0	0.01727	249.93	250.09	0.41107	0.0
200	50.0	0.01663	167.84	168.00	0.29381	****
150	50.0	0.01634	117.72	117.88	0.21481	****
328	100.0	0.01774	298.06	298.38	0.47401	0.0
200	100.0	0.01663	167.69	168.00	0.29381	****
150	100.0	0.01634	117.57	117.88	0.21481	****
358	150.0	0.01809	329.99	330.49	0.51372	0.0
200	150.0	0.01663	167.53	168.00	0.29381	****
150	150.0	0.01634	117.42	117.88	0.21481	****
382	200.0	0.01838	354.67	355.35	0.54343	0.0
200	200.0	0.01663	167.38	168.00	0.29381	****
150	200.0	0.01634	117.27	117.88	0.21481	****
401	250.0	0.01865	375.14	376.00	0.56745	0.0
200	250.0	0.01663	167.23	168.00	0.29381	****
150	250.0	0.01634	117.12	117.88	0.21481	****
417	300.0	0.01889	392.81	393.86	0.58778	0.0
200	300.0	0.01663	167.07	168.00	0.29381	****
150	300.0	0.01634	116.97	117.88	0.21481	****
432	350.0	0.01911	408.48	409.72	0.60550	0.0
200	350.0	0.01663	166.92	168.00	0.29381	****
150	350.0	0.01634	116.82	117.88	0.21481	****
445	400.0	0.01933	422.63	424.06	0.62128	0.0
200	400.0	0.01663	166.77	168.00	0.29381	****
150	400.0	0.01634	116.67	117.88	0.21481	****
456	450.0	0.01954	435.59	437.22	0.63554	0.0
200	450.0	0.01663	166.61	168.00	0.29381	****
150	450.0	0.01634	116.52	117.88	0.21481	****
467	500.0	0.01974	447.60	449.42	0.64858	0.0
200	500.0	0.01663	166.46	168.00	0.29381	****
150	500.0	0.01634	116.36	117.88	0.21481	****
477	550.0	0.01993	458.81	460.84	0.66064	0.0
200	550.0	0.01663	166.30	168.00	0.29381	****
150	550.0	0.01634	116.21	117.88	0.21481	****
486	600.0	0.02013	469.36	471.59	0.67186	0.0
200	600.0	0.01663	166.15	168.00	0.29381	****
150	600.0	0.01634	116.06	117.88	0.21481	****

**Appendix B**  
**STACK LOSS TABLES**





**Table B.1. Natural gas stack loss (%)**

Flue gas O <sub>2</sub> content (%)	Flue gas temperature—combustion air temperature (°F)														
	230	250	270	290	310	330	350	370	390	410	430	450	470	490	510
1.00	14.49	14.92	15.36	15.79	16.23	16.67	17.11	17.55	17.99	18.43	18.88	19.32	19.77	20.21	20.66
2.00	14.72	15.17	15.63	16.09	16.55	17.01	17.47	17.93	18.39	18.86	19.32	19.79	20.26	20.73	21.20
3.00	14.98	15.46	15.94	16.42	16.90	17.38	17.87	18.36	18.84	19.33	19.82	20.31	20.80	21.30	21.79
4.00	15.26	15.77	16.28	16.79	17.29	17.81	18.32	18.83	19.35	19.86	20.38	20.90	21.41	21.93	22.46
5.00	15.59	16.12	16.66	17.20	17.74	18.28	18.82	19.36	19.91	20.46	21.00	21.55	22.10	22.65	23.20
6.00	15.96	16.52	17.10	17.67	18.24	18.82	19.39	19.97	20.55	21.13	21.71	22.29	22.88	23.46	24.05
7.00	16.38	16.98	17.59	18.20	18.82	19.43	20.04	20.66	21.28	21.90	22.52	23.14	23.77	24.39	25.02
8.00	16.86	17.51	18.16	18.82	19.48	20.14	20.80	21.46	22.12	22.79	23.46	24.12	24.79	25.47	26.14
9.00	17.42	18.13	18.83	19.54	20.25	20.96	21.68	22.39	23.11	23.83	24.55	25.27	25.99	26.72	27.44
10.00	18.09	18.86	19.62	20.39	21.16	21.94	22.71	23.49	24.27	25.05	25.83	26.62	27.41	28.19	28.98
11.00	18.89	19.73	20.57	21.42	22.26	23.11	23.96	24.81	25.67	26.52	27.38	28.24	29.10	29.97	30.83
12.00	19.87	20.80	21.73	22.66	23.60	24.54	25.48	26.43	27.37	28.32	29.27	30.22	31.18	32.13	33.09

**Table B.2. No. 2 Fuel oil stack loss (%)**

Flue gas O <sub>2</sub> content (%)	Flue gas temperature—combustion air temperature (°F)														
	230	250	270	290	310	330	350	370	390	410	430	450	470	490	510
1.00	10.33	10.74	11.16	11.58	12.00	12.43	12.85	13.28	13.70	14.13	14.56	14.99	15.42	15.85	16.28
2.00	10.55	10.99	11.43	11.87	12.31	12.75	13.20	13.64	14.09	14.54	14.99	15.44	15.89	16.34	16.79
3.00	10.79	11.25	11.72	12.18	12.65	13.11	13.58	14.05	14.52	14.99	15.46	15.94	16.41	16.89	17.36
4.00	11.07	11.56	12.04	12.53	13.02	13.52	14.01	14.50	15.00	15.50	15.99	16.49	17.00	17.50	18.00
5.00	11.38	11.89	12.41	12.93	13.45	13.97	14.49	15.01	15.54	16.07	16.59	17.12	17.65	18.18	18.72
6.00	11.73	12.28	12.83	13.38	13.93	14.48	15.04	15.59	16.15	16.71	17.27	17.83	18.40	18.96	19.53
7.00	12.13	12.72	13.30	13.89	14.48	15.07	15.66	16.26	16.85	17.45	18.05	18.65	19.25	19.85	20.45
8.00	12.60	13.22	13.85	14.48	15.11	15.75	16.38	17.02	17.66	18.30	18.94	19.58	20.23	20.88	21.52
9.00	13.14	13.81	14.49	15.17	15.85	16.54	17.22	17.91	18.60	19.29	19.98	20.68	21.38	22.07	22.77
10.00	13.77	14.51	15.25	15.99	16.73	17.47	18.22	18.96	19.71	20.46	21.22	21.97	22.73	23.49	24.25
11.00	14.54	15.35	16.15	16.96	17.78	18.59	19.41	20.23	21.05	21.87	22.70	23.52	24.35	25.18	26.02
12.00	15.48	16.37	17.26	18.16	19.06	19.96	20.87	21.77	22.68	23.59	24.51	25.42	26.34	27.26	28.18

**Table B.3. No. 6 Fuel oil stack loss (%)**

Flue gas O <sub>2</sub> content (%)	Flue gas temperature—combustion air temperature (°F)														
	230	250	270	290	310	330	350	370	390	410	430	450	470	490	510
1.00	9.81	10.23	10.66	11.08	11.50	11.93	12.36	12.78	13.21	13.64	14.07	14.51	14.94	15.38	15.81
2.00	10.04	10.48	10.92	11.36	11.81	12.26	12.70	13.15	13.60	14.05	14.51	14.96	15.41	15.87	16.33
3.00	10.28	10.75	11.21	11.68	12.15	12.62	13.09	13.56	14.03	14.51	14.99	15.46	15.94	16.42	16.90
4.00	10.56	11.05	11.54	12.03	12.53	13.02	13.52	14.02	14.52	15.02	15.52	16.02	16.53	17.03	17.54
5.00	10.87	11.39	11.91	12.43	12.96	13.48	14.01	14.53	15.06	15.59	16.12	16.66	17.19	17.72	18.26
6.00	11.23	11.78	12.33	12.88	13.44	14.00	14.56	15.12	15.68	16.24	16.81	17.37	17.94	18.51	19.08
7.00	11.63	12.22	12.81	13.40	13.99	14.59	15.18	15.78	16.38	16.98	17.59	18.19	18.79	19.40	20.01
8.00	12.10	12.73	13.36	13.99	14.63	15.27	15.91	16.55	17.19	17.84	18.49	19.13	19.78	20.43	21.09
9.00	12.64	13.32	14.00	14.69	15.38	16.06	16.75	17.45	18.14	18.84	19.54	20.23	20.94	21.64	22.34
10.00	13.28	14.02	14.76	15.51	16.26	17.00	17.75	18.51	19.26	20.02	20.78	21.54	22.30	23.06	23.83
11.00	14.05	14.87	15.68	16.49	17.31	18.13	18.95	19.78	20.61	21.43	22.27	23.10	23.93	24.77	25.61
12.00	15.00	15.89	16.79	17.70	18.60	19.51	20.42	21.33	22.25	23.17	24.09	25.01	25.93	26.86	27.79

**Table B.4. Typical bituminous coal stack loss (%)**

Flue gas O <sub>2</sub> content (%)	Flue gas temperature—combustion air temperature (°F)														
	230	250	270	290	310	330	350	370	390	410	430	450	470	490	510
1.00	8.37	8.80	9.23	9.67	10.11	10.55	10.99	11.43	11.87	12.31	12.76	13.21	13.65	14.10	14.55
2.00	8.59	9.05	9.50	9.96	10.42	10.88	11.34	11.80	12.27	12.73	13.20	13.67	14.14	14.61	15.08
3.00	8.85	9.32	9.80	10.28	10.76	11.25	11.73	12.22	12.71	13.20	13.69	14.18	14.67	15.17	15.66
4.00	9.13	9.63	10.14	10.64	11.15	11.66	12.17	12.68	13.20	13.71	14.23	14.75	15.27	15.79	16.31
5.00	9.44	9.98	10.51	11.05	11.59	12.12	12.67	13.21	13.75	14.30	14.84	15.39	15.94	16.49	17.05
6.00	9.80	10.37	10.94	11.51	12.08	12.65	13.22	13.80	14.38	14.96	15.54	16.12	16.70	17.29	17.88
7.00	10.22	10.82	11.42	12.03	12.64	13.25	13.86	14.48	15.10	15.71	16.33	16.95	17.58	18.20	18.83
8.00	10.69	11.34	11.99	12.64	13.29	13.95	14.60	15.26	15.92	16.58	17.25	17.91	18.58	19.25	19.92
9.00	11.24	11.94	12.64	13.34	14.05	14.75	15.46	16.17	16.89	17.60	18.32	19.04	19.75	20.48	21.20
10.00	11.90	12.66	13.42	14.18	14.94	15.71	16.48	17.25	18.03	18.80	19.58	20.36	21.14	21.92	22.71
11.00	12.68	13.51	14.35	15.18	16.02	16.86	17.70	18.55	19.39	20.24	21.10	21.95	22.81	23.66	24.52
12.00	13.64	14.56	15.48	16.41	17.33	18.26	19.19	20.13	21.07	22.01	22.95	23.89	24.84	25.79	26.74

**INTERNAL DISTRIBUTION**

- |                    |                                  |
|--------------------|----------------------------------|
| 1. D. F. Cox       | 6. M. Olszewski                  |
| 2. E. C. Fox       | 7-9. A. L. Wright                |
| 3. R. E. Leach     | 10. J. M. Young                  |
| 4. K. L. McElhaney | 11. ORNL Laboratory Records (RC) |
| 5. C. B. Oland     |                                  |

**EXTERNAL DISTRIBUTION**

- 12-14. G. Harrell, Ph.D., P.E., Senior Research Associate, The University of Tennessee  
Knoxville, Energy, Environment and Resources Center, 311 Conference Center Building,  
Knoxville, TN 37996-4134
- 15-17. F. Hart, U.S. Department of Energy, EE-24, 1000 Independence Avenue, SW,  
Washington, DC 20585-0121
- 18-20. C. Russell, Alliance to Save Energy, 1200 18th Street, NW, Suite 900, Washington, DC  
20036